

Hisense

Refrigerator

Service Manual

Model:

RL-42W42S/W8-001-001

RL-42W41S/C2V-001-001

Contents

1.Warnings and precautions for safety	1
2.Appearance and structure	2
2.1 View of the appliance	2
2.2 Wind channel structure	3
2.3 Fridge evaporator structure	4
2.4 Compressor room structure.....	5
3.Basic parameters	6
4.Operation and functions	7
4.1 Display controls.....	7
4.2 Reversing the door.....	10
4.3 Error Code	14
5.Troubleshooting	15
5.1 Common problem and checking.....	15
5.2 Faulty start	17
5.3 Refrigeration failure.....	18
5.4 Thick frost in freezer compartment	21
5.5 Dew in refrigerator compartment	22
5.6 Breaking of light	23
5.7 Noise.....	24
6.Circuit and checking	28
6.1 Circuit diagram.....	28
6.2 Mainboard.....	28
6.3 Compressor	32
6.4 Fan motor	32
6.5 Light.....	33
6.6 Display panel	34
6.7 Sensor	35
6.8 Door switch	35
6.9 Removing environment temperature sensor unit	36
7.Cooling system repairing	37
7.1 Refrigeration system	37
7.2 Summary of repair.....	38
7.3 Regulation of repair	39
7.4 Practical work of repair.....	40
7.5 Brazing reference drawing	41

1. Warning and precautions for safety

Please observe the following safety precautions in order to use safely and correctly the refrigerator and to prevent accident and danger during repair.

1. Be care of an electric shock. Disconnect power cord from wall outlet and wait for more than three minutes before replacing PCB parts. Shut off the power whenever replacing and repairing electric components.
2. When connecting power cord, please wait for more than five minutes after power cord was disconnected from the wall outlet.
3. Please check if the power plug is pressed down by the refrigerator against the wall. If the power plug was damaged, it may cause fire or electric shock.
4. If the wall outlet is over loaded, it may cause fire. Please use its own individual electrical outlet for the refrigerator.
5. Please make sure the outlet is properly earthed, particularly in wet or damp area.
6. Use standard electrical components when replacing them.
7. Make sure the hook is correctly engaged. Remove dust and foreign materials from the housing and connecting parts.
8. Do not fray, damage, machine, heavily bend, pull out or twist the power cord.
9. Please check the evidence of moisture intrusion in the electrical components. Replace the parts or mask it with insulation tapes if moisture intrusion was confirmed.
10. Do not touch the ice maker with hands or tools to confirm the operation of geared motor.
11. Do not let the customers repair, disassemble and reconstruct the refrigerator for themselves. It may cause accident, electric shock, or fire.
12. Do not store flammable materials such as ether, benzene, alcohol, chemicals, gas, or medicine in the refrigerator.
13. Do not put flower vase, cup, cosmetics, chemicals, etc., or container with full of water on the top of the refrigerator.
14. Do not put glass bottles with full of water into the freezer. The contents shall freeze and break the glass bottles.
15. When you scrap the refrigerator, please disconnect the door gasket first and scrap it.

2. Appearance and structure

2.1 View of the appliance

BC-319WY3NF1A/HC4(E) RL-42W42S/W8-001-001

1. Cabinet
2. LED light
3. Glass shelves
4. Bottle rack (optional)
5. Display
6. Small glass shelf
7. 0° C cool plus
8. Crisper box
9. Adjustable bottom feet
10. Egg tray (inside)
11. Upper racks
12. Handle (optional)
13. Lower racks
14. Bottle holder (optional)
15. Fridge door
16. Fridge gasket

View of the appliance

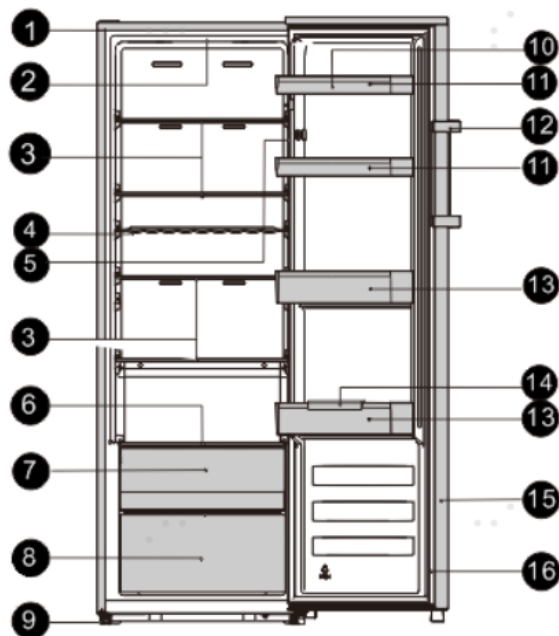

Note: Due to unceasing modification of our products, your refrigerator may be slightly different from this instruction manual, but its functions and using methods remain the same. To get more space in the freezer, you can remove drawers (except lower freezer drawer), ice tray.

2.2 Wind channel structure

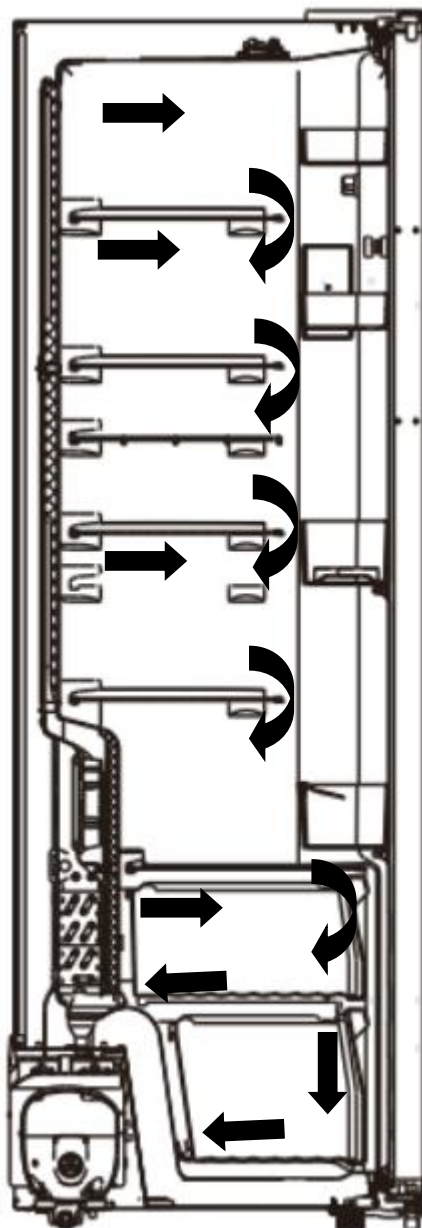

2.3 Fridge evaporator structure

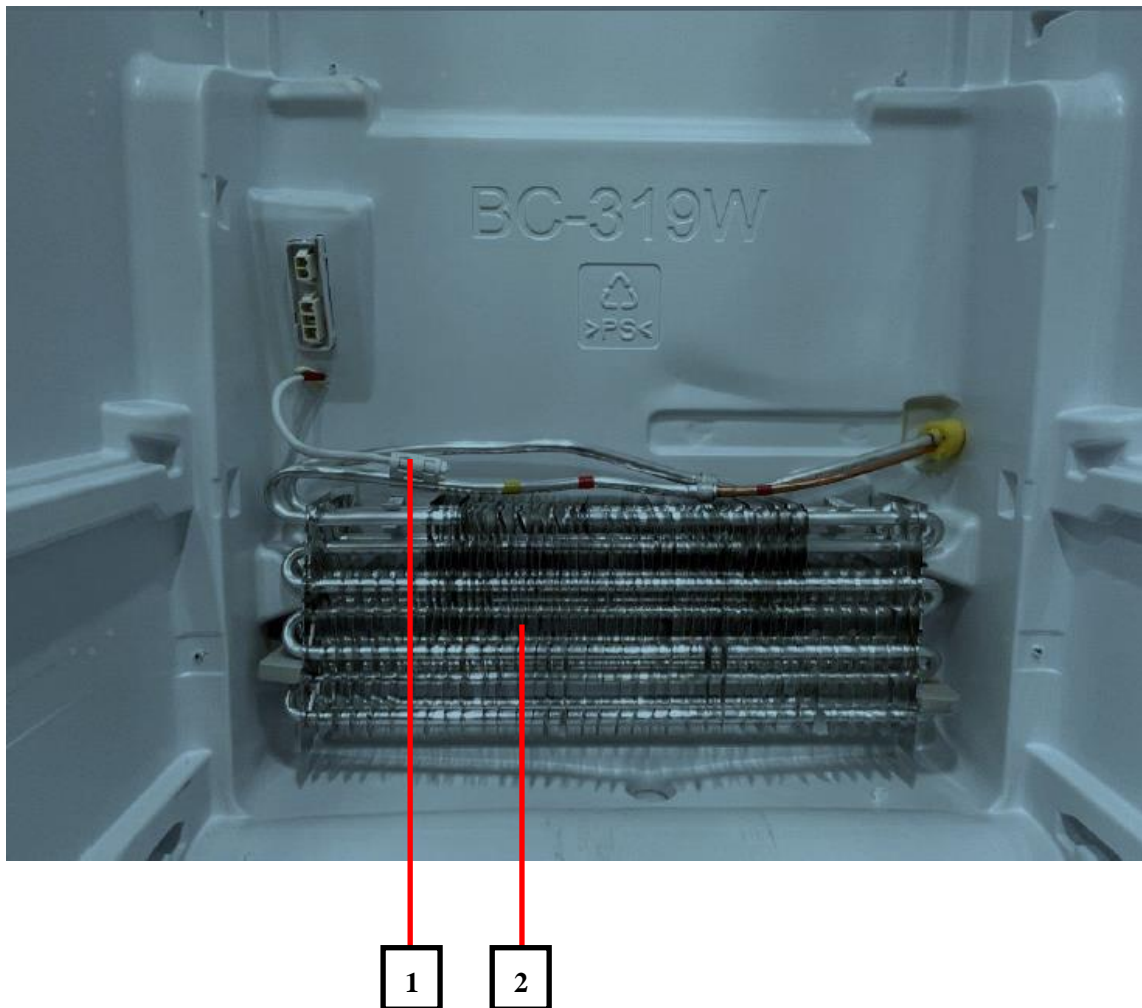

1. Temperature sensor part
2. Wing slice evaporator part

2.4 Compressor room structure

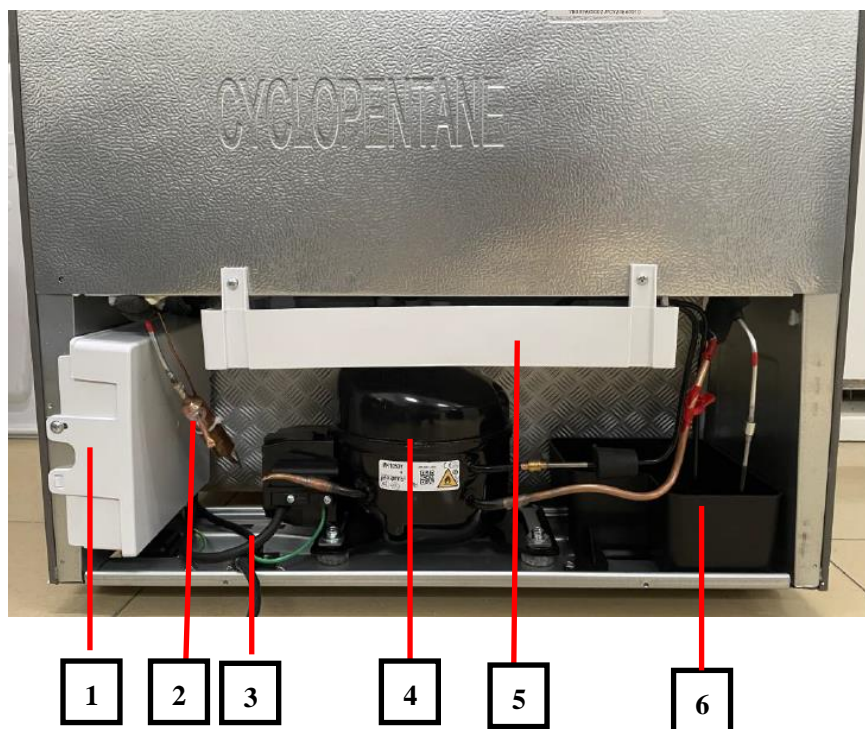

1. Junction box
2. Dry filter
3. Power line
4. Compressor
5. Up evaporating dish part
6. Lower evaporating dish part

3. Basic parameters

BC-319WY3NF1A/HC4(E) RL-42W42S/W8-001-001

Content	Unit	Value
Voltage/frequency		220-240V / 50Hz
Storage volume (fridge)	L	322
Energy efficiency class (V NEW Energy 2020)		E
Climate class		SN/N/ST/T
Energy consumption / year	kWh/year	137
Energy consumption (EN153) per 24 h	kWh/24 h	0.375
Kind of coolant /Charge (134 /R600a) / grammes	R / g	R600a/40
Foaming components (R141b/C-P)	PU/	C-P
Certifications (CE / ISO 9001/2 / LGA etc.)		CE+GS+CB, UKCA
Max noise level	dB(A)	38

BC-319WY3NF1/HC4(E) RL-42W41S/C2V-001-001

Content	Unit	Value
Voltage/frequency		220-240V / 50Hz
Storage volume (fridge)	L	322
Energy efficiency class (NEW Energy 2020)		F
Climate class		SN/N/ST/T
Energy consumption / year	kWh/year	171
Energy consumption (EN153) per 24 h	kWh/24 h	0.469
Kind of coolant /Charge (134 /R600a) / grammes	R / g	R600a/40
Foaming components (R141b/C-P)	PU/	C-P
Certifications (CE / ISO 9001/2 / LGA etc.)		CE+GS+CB, UKCA
Max noise level	dB(A)	38

BC-319WY3NF1/HC4(E) RL-42W41S/C2V-001-001

Content	Unit	Value
Voltage/frequency		220-240V / 50Hz
Storage volume (fridge)	L	312
Energy efficiency class (OLD Energy)		A+
Climate class		SN/N/ST/T
Energy consumption / year	kWh/year	161
Energy consumption (EN153) per 24 h	kWh/24 h	0.441
Kind of coolant /Charge (134 /R600a) / grammes	R / g	R600a/40
Foaming components (R141b/C-P)	PU/	C-P
Certifications (CE / ISO 9001/2 / LGA etc.)		CE+CB+GS
Max noise level	dB(A)	38

Hisense Refrigerator

4. Operation and functions

4.1 Display controls

Use your appliance according to the following control regulations, your appliance has the corresponding functions and modes as the control panels showed in the pictures below. When the appliance is powered on for the first time, the backlighting of the icons on display panel starts working. If no buttons have been pressed and the doors are closed, the backlighting will turn off.

Display panel inside

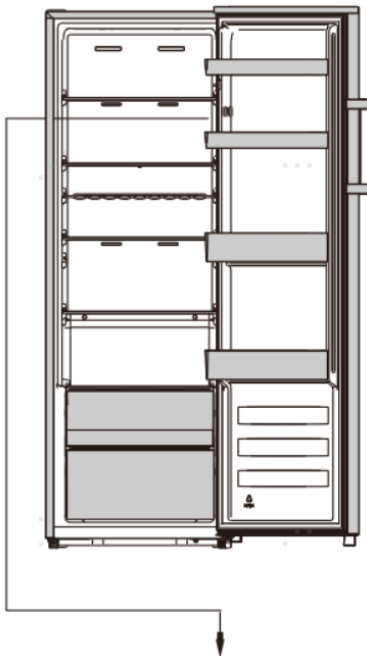

Controlling the temperature

For optimum food preservation, We recommend that when you start your refrigerator for the first time, the temperature for the refrigerator is set to 4°C (39°F), if you want to change the temperature, follow the instructions below

Caution!

When you set temperature, you set an average temperature for the whole refrigerator cabinet. Temperature inside each compartment may vary from the temperature values displayed on the panel, depending on how much food you store and where you place them. Ambient temperature may also affect the actual temperature inside the appliance.

Note: High temperature setting will accelerate food waste.

1. Temp

In the unlocked state, you can switch the display mode from °C to °F by press the

Set Temp.
°C/°F Hold 3sec button for 3 seconds.

In the unlocked state, press

Set Temp.
°C/°F Hold 3sec button, when the °C

light is on, the fridge set temperature is cyclically adjusted between 8°C and 2°C.

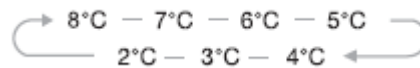

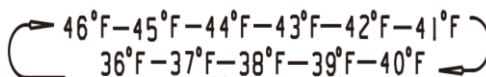

when the °F light is on, the fridge set temperature is cyclically adjusted between 46°F and 36°F.

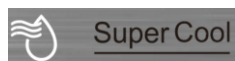

2. Super Cool



Super Cool can refrigerate your food much faster, keeping food fresh for longer period.

- In the unlocked state, press  button to enter the Super Cool mode, the Super Cool icon is lit and the temperature is set to 2°C(36°F).
- Super Cool mode automatically exits after about 6 hours.
- When Super Cool function is on, in the unlocked state, you can switch it off by pressing  button and the refrigerator temperature setting will revert back to the previous setting.

3. Eco

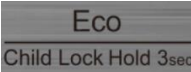
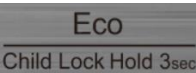

If you are going to be away for a long period of time, you can turn it to Eco mode to save on electricity.

- In the unlocked state, press  button to enter the Eco mode, the Eco icon is lit and the temperature is set to 6°C (43°F) .
- When the Eco function is on, in the unlocked state, you can switch it off by pressing  button. The fridge temperature setting will revert back to the previous setting.

4. Child Lock

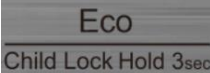

- When the  light is on, the fridge is locked. Press and hold the  button for 3 seconds, the



light is off. the fridge is in the unlocked state. it can perform other button operation.

- If no button have been press for 20 seconds, the  light will be on.

5. Alarm

-  In case of alarm,  icon will be flashing and there will be buzzing sound.

Door Alarm

- When the door is open for over 2 minutes, the door alarm will sound, meanwhile the display panel show “dr” . In case of door alarm, buzzer will sound 3 times every 1 min.
- After the door alarm time exceeds more than 10 minutes, the buzzer stops beeping, the  icon is off, and the display screen shows normal. The door alarm can also be cleared by closing the door.
- To save energy, please avoid keeping the door open for a long time when using the appliance.



6. Power



Pressing and hold the



button for 3 seconds to turn the power function on or off.

- When the refrigerator is working, In the unlocked state, you can switch the appliance off by pressing  button for 3 seconds, the  light is on, meanwhile the display panel show “- -” . Important! Do not store any food in the

fridge during this time.

●When the refrigerator is in standby mode

and unlocked, press the  button









for 3 seconds, the  light is off, the

refrigerator will turn on and the display will show normal.

Note: The display control only can be set in the unlocked state

4.2 Reversing the door

The side in which the door opens can be changed from the right side (as supplied) to the left side, if the installation site allows for it. Tools you will need:

Not provided		
		
8mm socket wrench	Thin-blade screwdriver	Putty knife
		
Cross-shaped screwdriver	Monkey wrench	7mm wrench
Additional parts(in the plastic bag)		
		
Left Hinge		
		
Left Hinge Cover		
		
Right Screw Cover		

Note: Before you start lay the refrigerator on it's back in order to gain access to the base, you should rest it on soft foam packaging or similar material to avoid damaging the backboard of the refrigerator. To reverse the door. The following steps are generally recommended.

1 . Stand the refrigerator upright. Open the door to take out all door racks (to avoid racks damaged) .

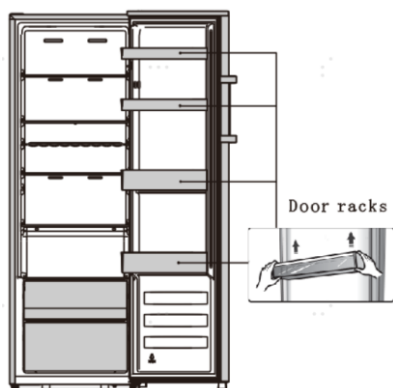

2. Remove the screw hole cover and upper

hinge cover (right) as follow diagram.

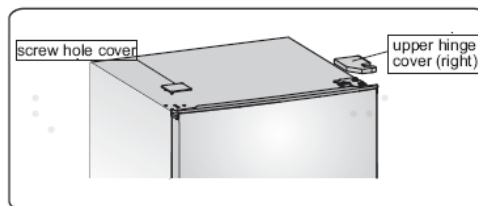

3. Remove the three screws as follow diagram. Lift the right upper hinge part.

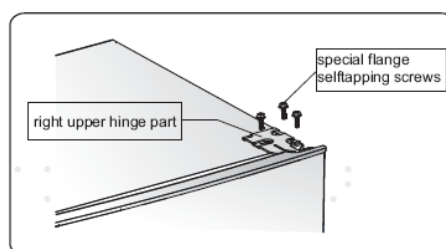

4.Lift the door and place it on a padded surface to prevent scratching.

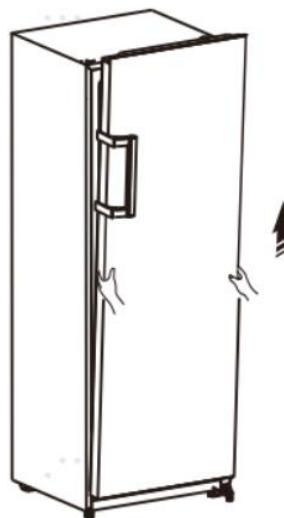

5. Loose screw ② and screws ⑤ , detach part ① and part ③ part ④ . Replace part ① to the right side and tighten securely with screw ② . Replace part ③ and part ④ to the left side and tighten securely with screws ⑤ .

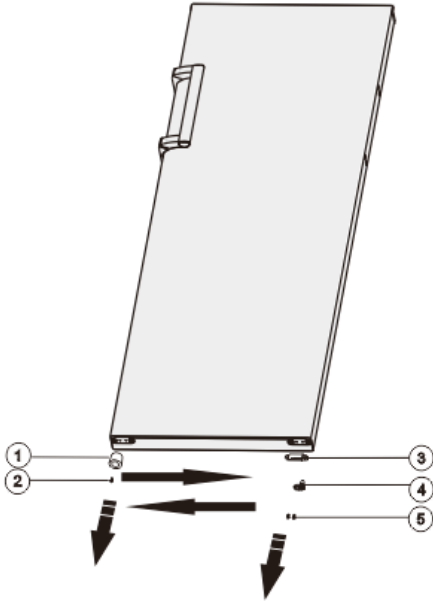

- ① Support block for door frame
- ② Self-tapping screw
- ③ Door stopper
- ④ Limit block
- ⑤ Self-tapping screw

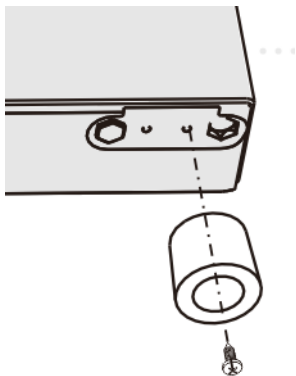
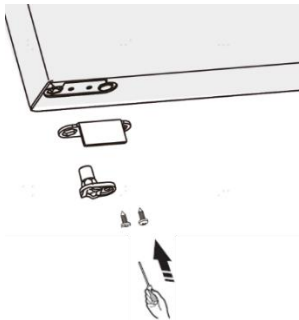

6. Lay the refrigerator on soft foam packaging or similar material. Remove part ① part ②, and part ③ by unscrewing

the screws ④.

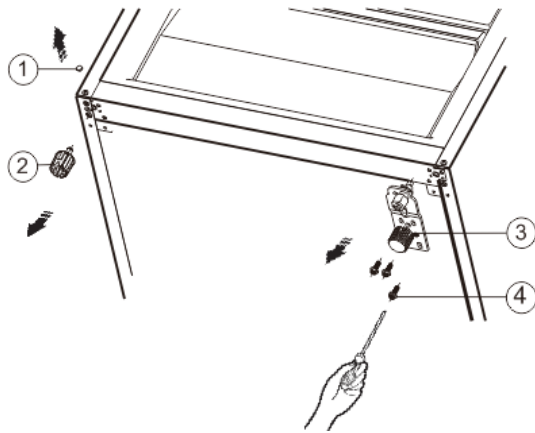

- ① Screw cover
- ② Adjustable bottom feet part
- ③ Right lower hinge part
- ④ Special flange self-tapping screw

7. Replace part ③ to the left side and fixing it with the screws ④ . Replace part ① and part ② to another side and fixing it.

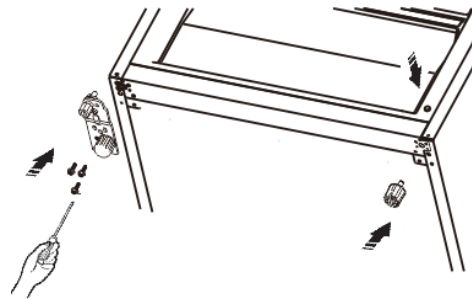

Note: 1. You need move hinge axis from hole ① to ② , move adjustable bottom feet part from hole ③ to ④ before transfer.

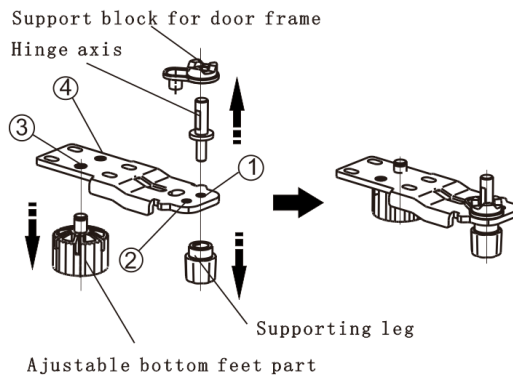

8. Set the door into its new place making sure the pin enters the bushing at the lower frame section.

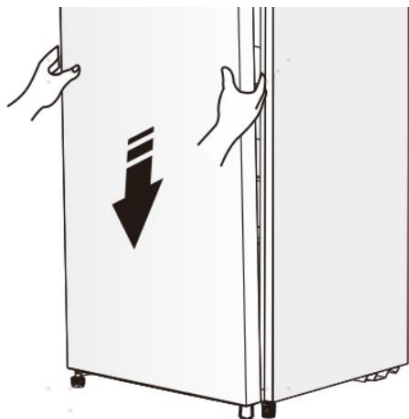

9. Replace the lid by fitting the upper hinge core into the upper door's hole, securing it with the 3 screws.

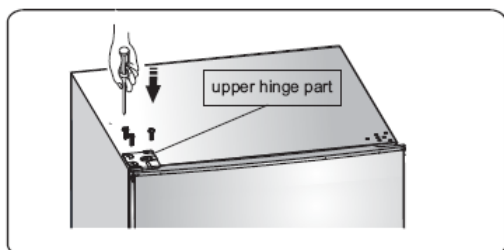

10. Put the screw hole cover and upper hinge cover (left) as follow diagram.

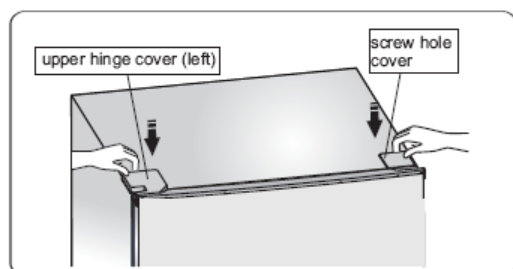

11. Switch the handles from the left to the right (only for the model with handles) .

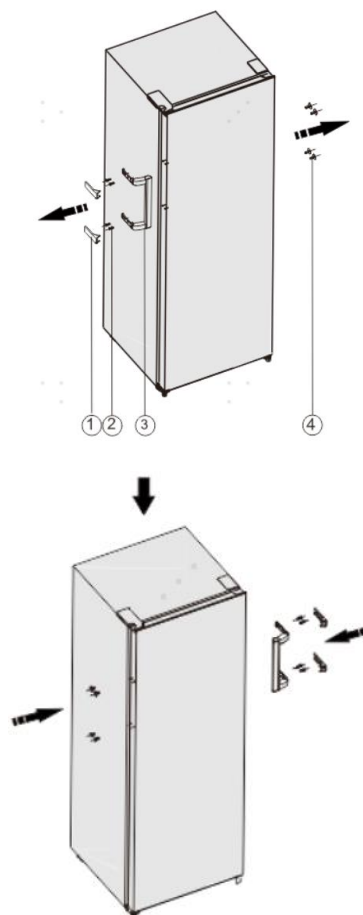

- ① Handle cover
- ② Screw
- ③ Handle part
- ④ Cover-screw cap

Note !

Due to unceasing modification of our products, handle may be slightly different from this instruction manual, but its functions and using methods remain the same. Switch the handles from the left to the right as follow diagram.

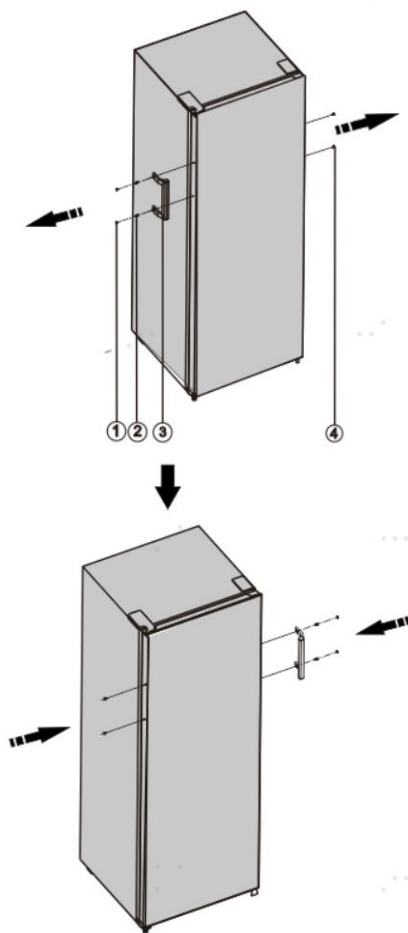

- ① Screw cover
- ② Screw

- ③ Handle part
- ④ Cover-screw cap

Warning !

When changing the side at which the door opens, the appliance must not be connected to the mains. Remove plug from the mains beforehand.

4.3 Error Code

Code	Problem	Analysis	Solutions
E0	Refrigerator sensor malfunctions	<ol style="list-style-type: none"> 1. The Environmental Tem. Sensor is open circuit or short circuit. 2. The Environmental Tem. Sensor is bad. 3. The display PCB is bad. 4. The control PCB is bad 	<ol style="list-style-type: none"> 1. Using a Multimeter with the ohm switch to measure the resistor of sensor or checking the connect ing is well or not. 2. Change the sensor 3. Change the display PCB. 4. Change the control PCB
E1	Refrigerator sensor malfunctions	<ol style="list-style-type: none"> 1. The fridge chamber Tem. Sensor is open circuit or short circuit. 2. The fridge chamber Tem. . Sensor is bad. 3. The control PCB is bad. 	<ol style="list-style-type: none"> 1. Using a Multimeter with the ohm switch to measure the resistor of sensor or checking the connect ing is well or not. 2. Change the sensor 3. Change the control PCB
E2	Refrigerator evaporator sensor malfunctions	<ol style="list-style-type: none"> 1. The Evaporator Defrost Sensor is open circuit or short circuit. 2. The Evaporator Defrost Sensor is bad. 3. The control PCB is bad. 	<ol style="list-style-type: none"> 1. Using a Multimeter with the ohm switch to measure the resistor of sensor or checking the connect ing is well or not. 2. Change the sensor 3. Change the control PCB
Ec	Communication sending malfunctions	<ol style="list-style-type: none"> 1. The receive communicat ion fault between the main electrical PCB and the display PCB. 2. The control PCB is bad. 3. The display PCB is bad. 	<ol style="list-style-type: none"> 1. Check the wire terminal is well or not between the main electrical PCB and display PCB. 2. Change the main electrical PCB. 3. Change the display PCB.
Er	Communication receiving malfunctions	<ol style="list-style-type: none"> 1. The send communicat ion fault between the main electrical PCB and the display PCB. 2. The control PCB is bad. 3. The display PCB is bad. 	<ol style="list-style-type: none"> 1. Check the wire terminal is well or not between the main electrical PCB and display PCB. 2. Change the main electrical PCB. 3. Change the display PCB.
F2	Refrigerator fan malfunctions	<ol style="list-style-type: none"> 1. The fridge fan motor is open circuit or short circuit. 2. The Fan motor is bad. 3. The control PCB is bad. 	<ol style="list-style-type: none"> 1. Using a Multimeter with the ohm switch to measure the resistor of the cool Fan motor or checking the connecting is well or not. 2. Change the Fan motor 3. Change the control PCB

5. Trouble shooting

5.1 Common problem and checking

If you experience a problem with your appliance or are concerned that the appliance is not functioning correctly, you can carry out some easy checks before calling for service, please see below.

Warning! Don't try to repair the appliance yourself. If the problem persists after you have made the checks mentioned below, contact a qualified electrician, authorized service engineer or the shop where you purchased the product.

Problem	Possible cause & Solution
Appliance is not working correctly	Check whether the power cord is plugged into the power outlet properly.
	Check the fuse or circuit of your power supply, replace if necessary.
	It is normal that the freezer is not operating during the defrost cycle, or for a short time after the appliance is switched on to protect the compressor.
	The interior may need to be cleaned
	Some food, containers or wrapping cause odours.
Noise from the appliance	The sounds below are quite normal: <ul style="list-style-type: none"> •Compressor running noises. •Air movement noise from the small fan motor in the freezer compartment or other compartments. •Gurgling sound similar to water boiling. •Popping noise during automatic defrosting. •Clicking noise before the compressor starts.
	Other unusual noises are due to the reasons below and may need you to check and take action: <ul style="list-style-type: none"> •The cabinet is not level. •The back of appliance touches the wall. •Bottles or containers fallen or rolling.
A layer of frost occurs in the compartment	Check that the air outlets are not blocked by food and ensure food is placed within the appliance to allow sufficient ventilation. Ensure that door is fully closed. To remove the frost, please refer to the "Cleaning and care" chapter.
Temperature inside is too warm	You may have left the doors open too long or too frequently; or the doors are kept open by some obstacle; or the appliance is located with insufficient clearance at the sides, back and top

Temperature inside is too cold	Increase the temperature by following the “Display controls” chapter.
Doors can't be closed easily	Check whether the top of the refrigerator is tilted back by 10-15mm to allow the doors to self close, or if something inside is preventing the doors from closing.
The light is not working	<ul style="list-style-type: none">•The LED light may be damaged. Refer to replace LED lights in “Cleaning and Care” chapter of manual.•The control system has disabled the lights due to the door being kept open too long. Close and reopen the door to reactivate the lights.

5.2 Faulty start

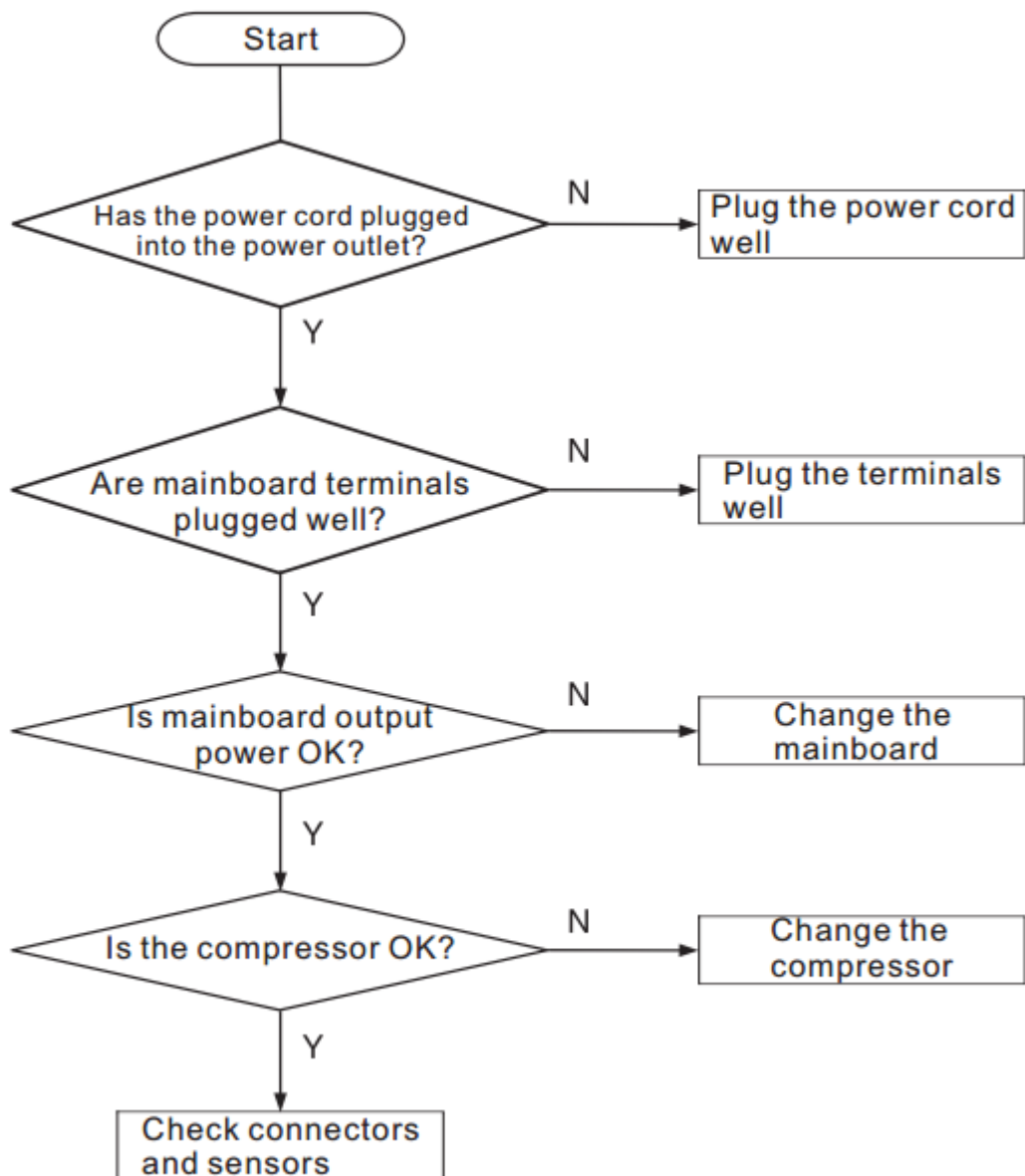

5.3 Refrigeration failure

5.3.1 Fridge compartment

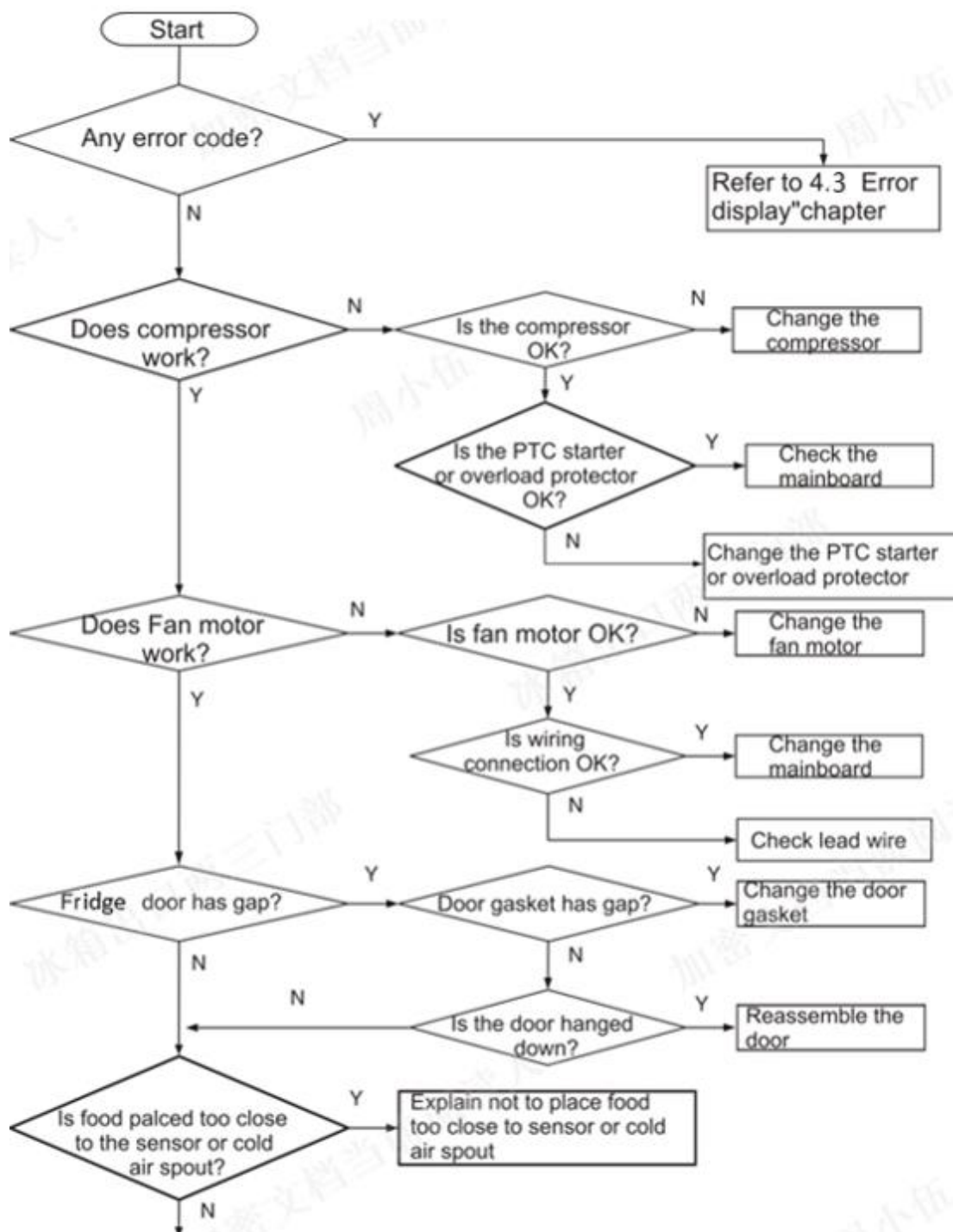

5.3.1 Fridge compartment

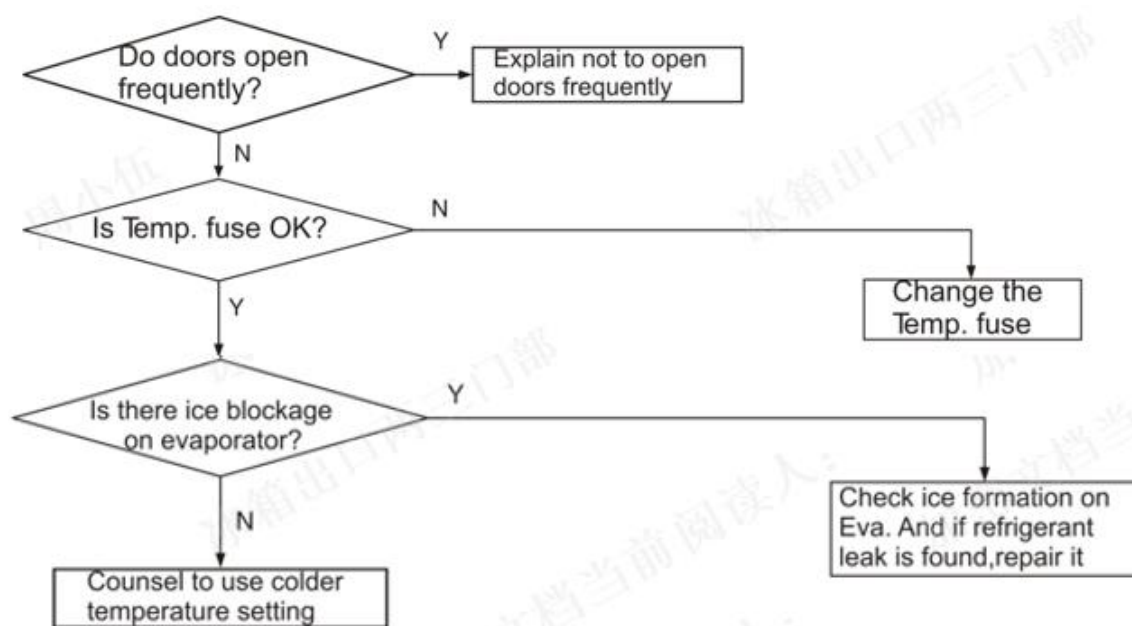

5.3.2 Refrigerator compartment

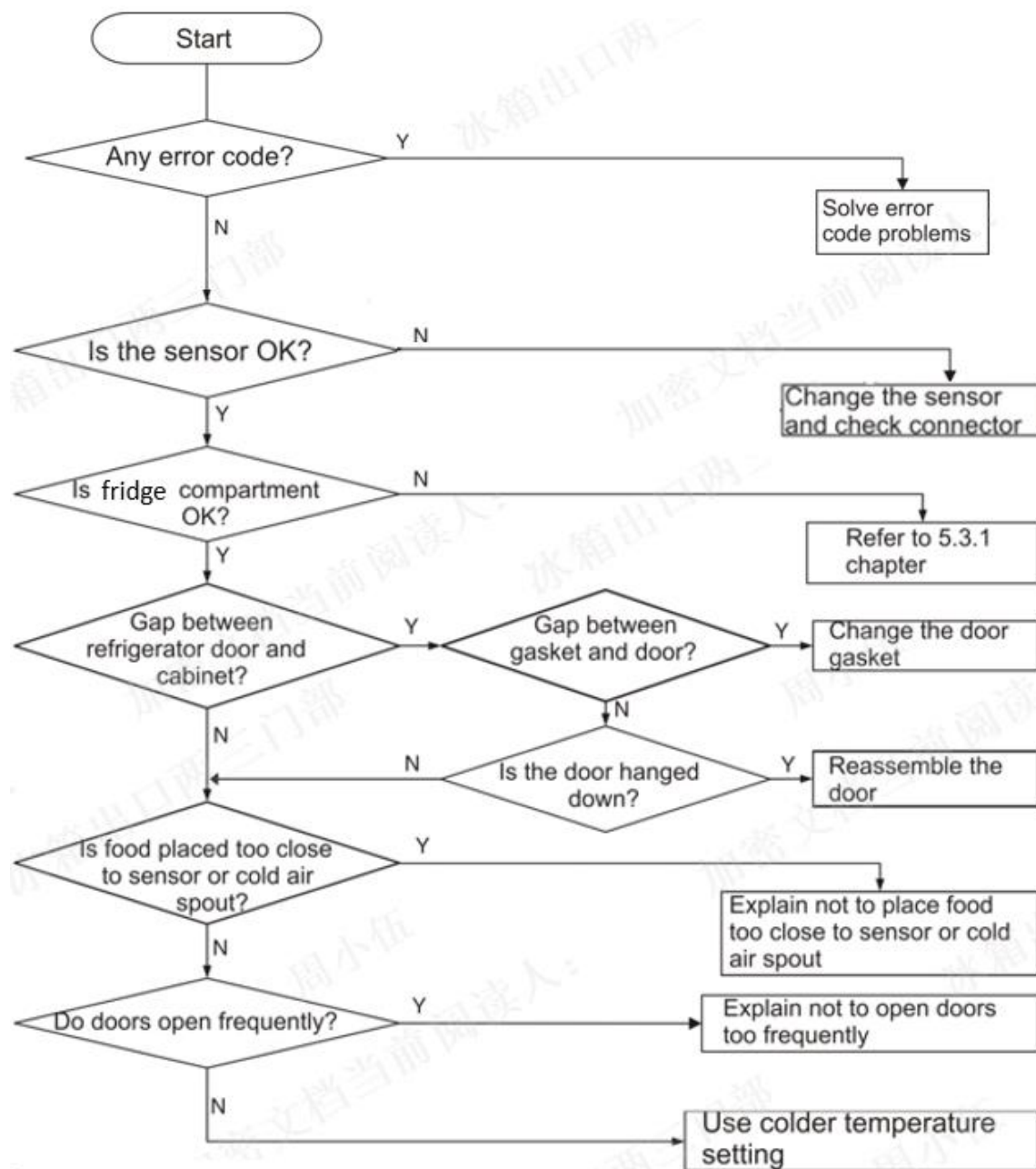

5.4 Thick frost in refrigerator compartment

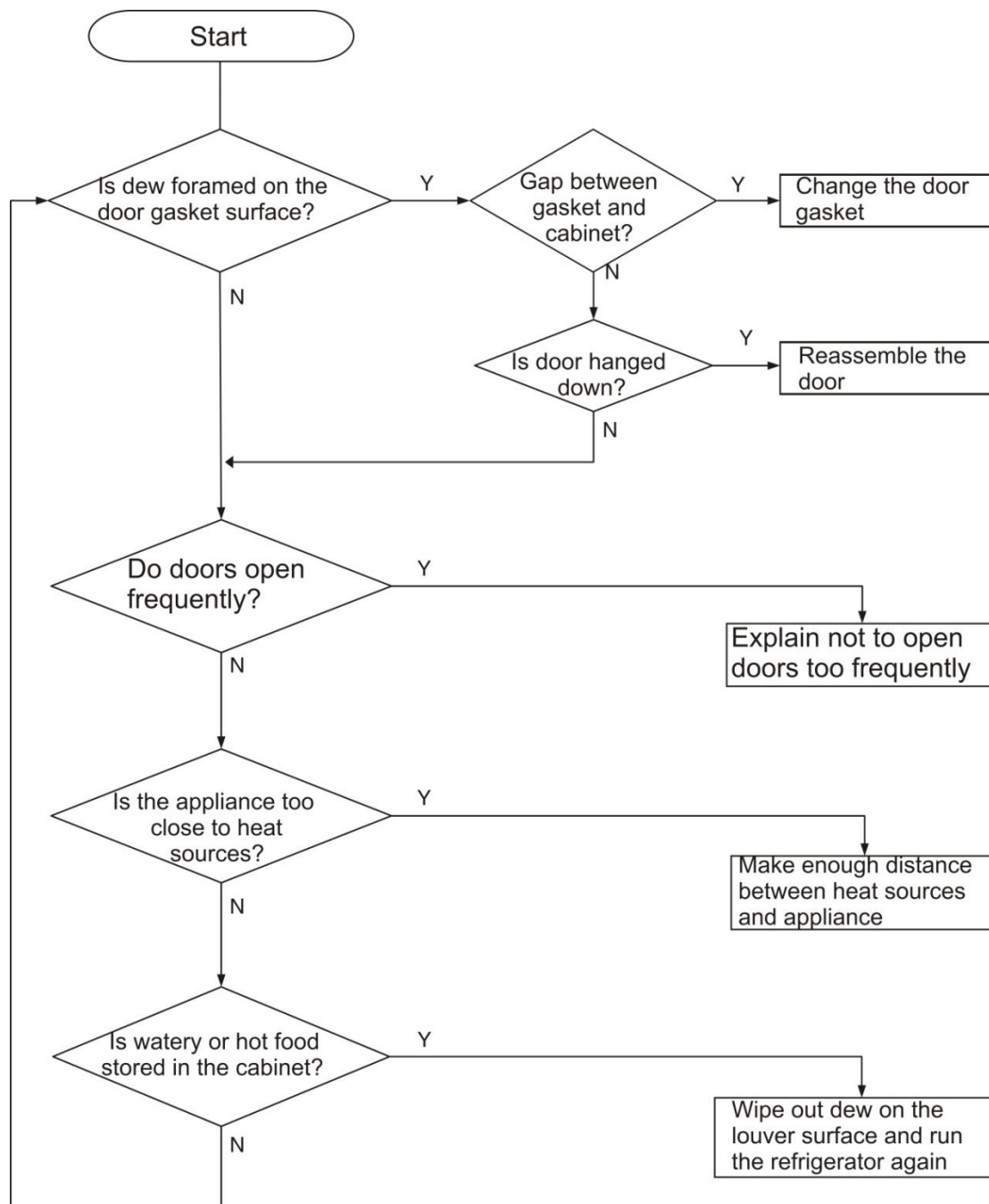

5.5 Dew in refrigerator compartment

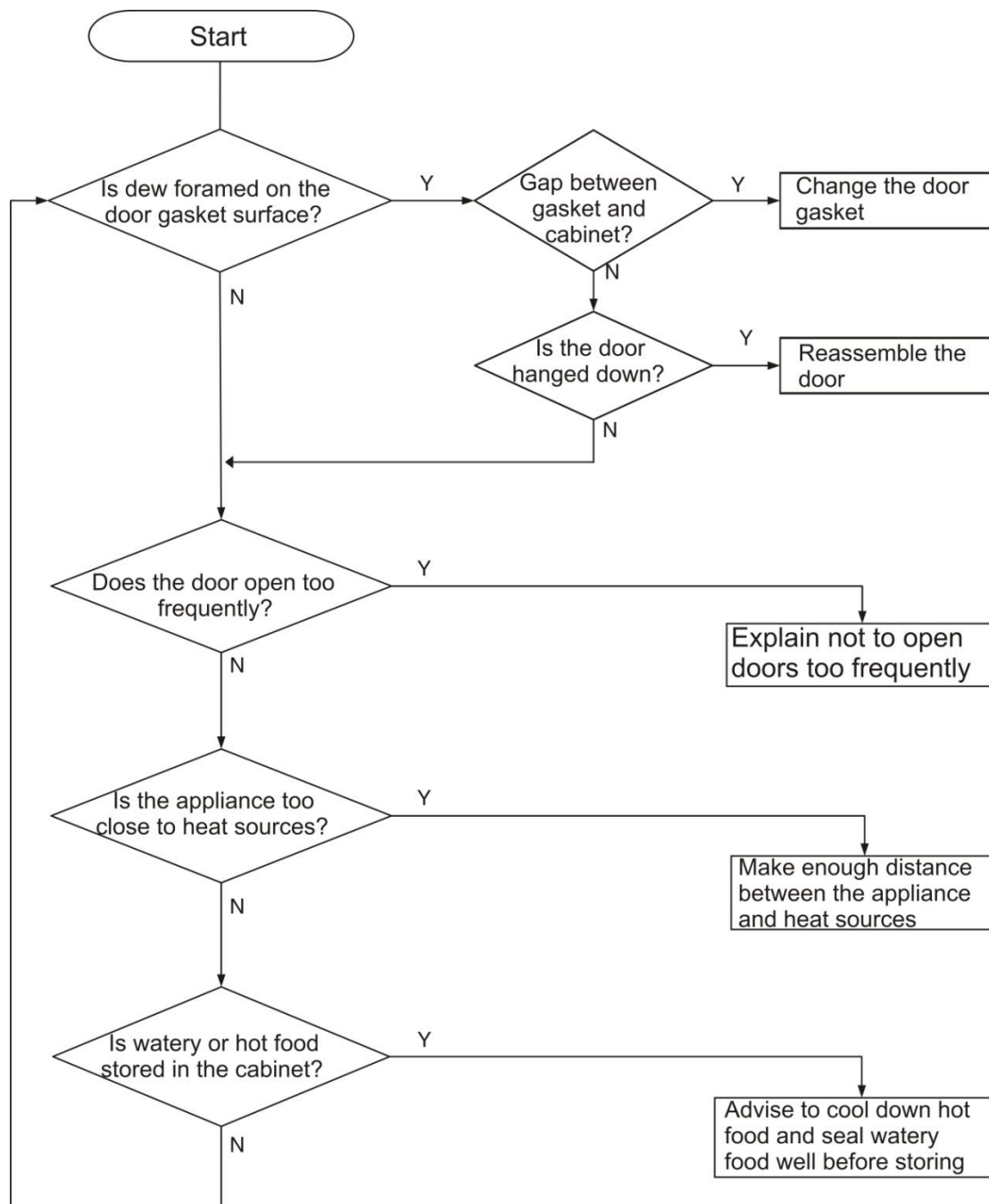

5.6 Breaking of light

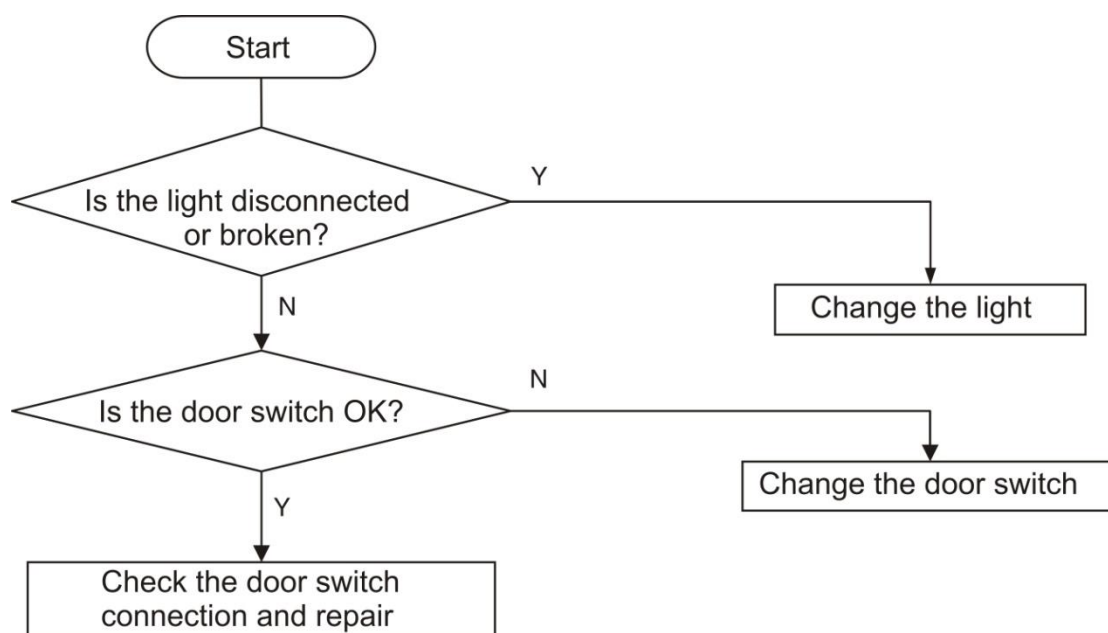

5.7 Noise

5.7.1 Compressor noise

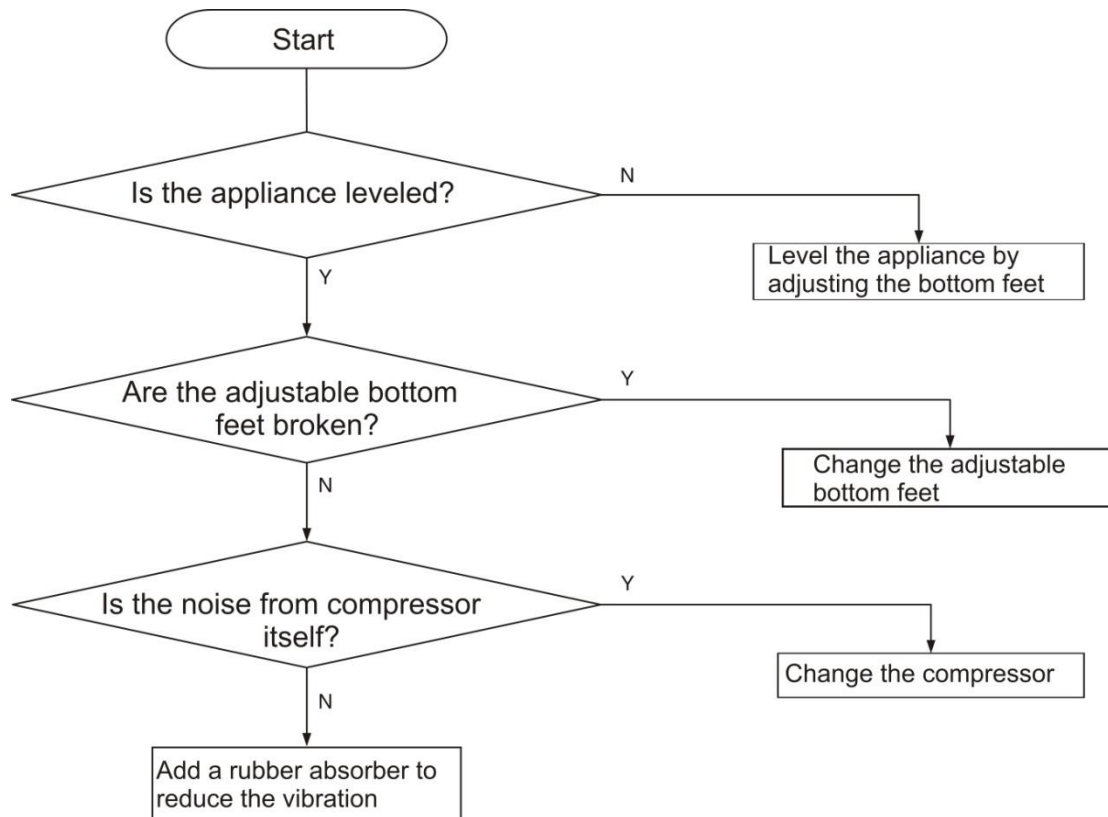

5.7.2 Refrigerator flowing noise

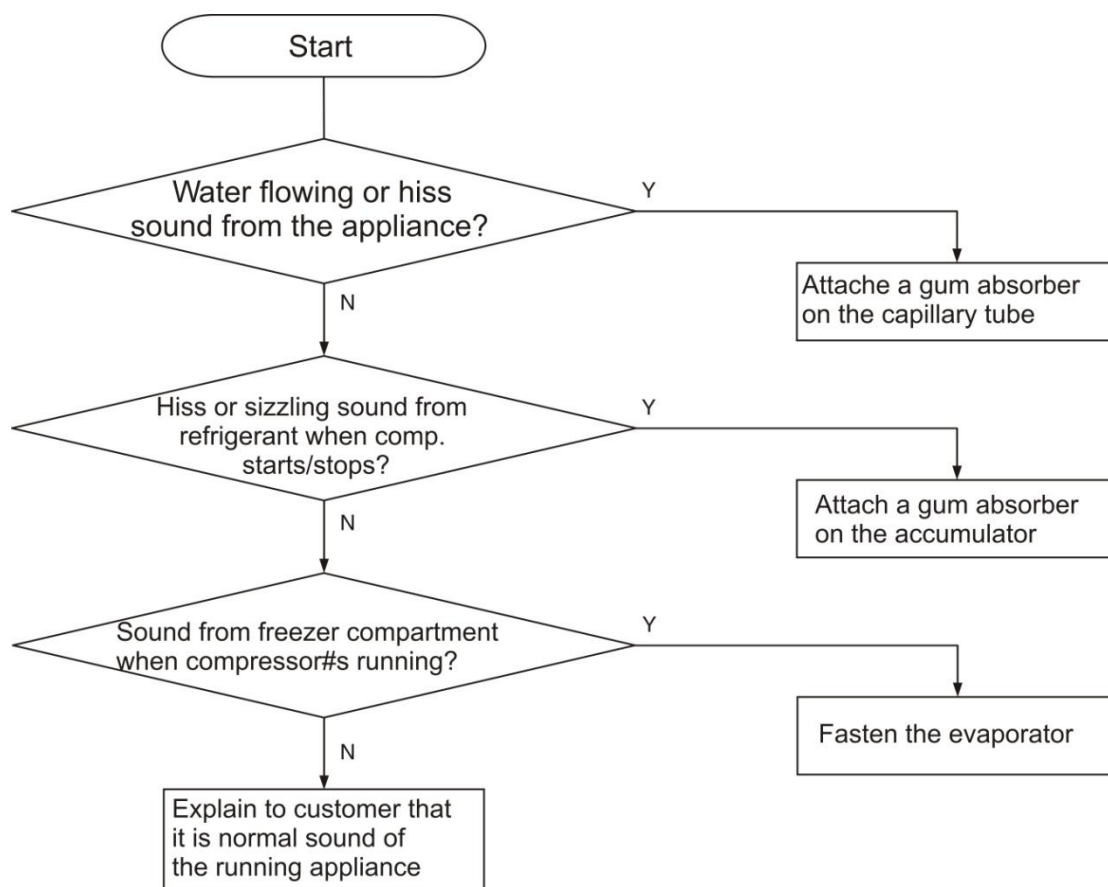

5.7.3 Fan motor noise

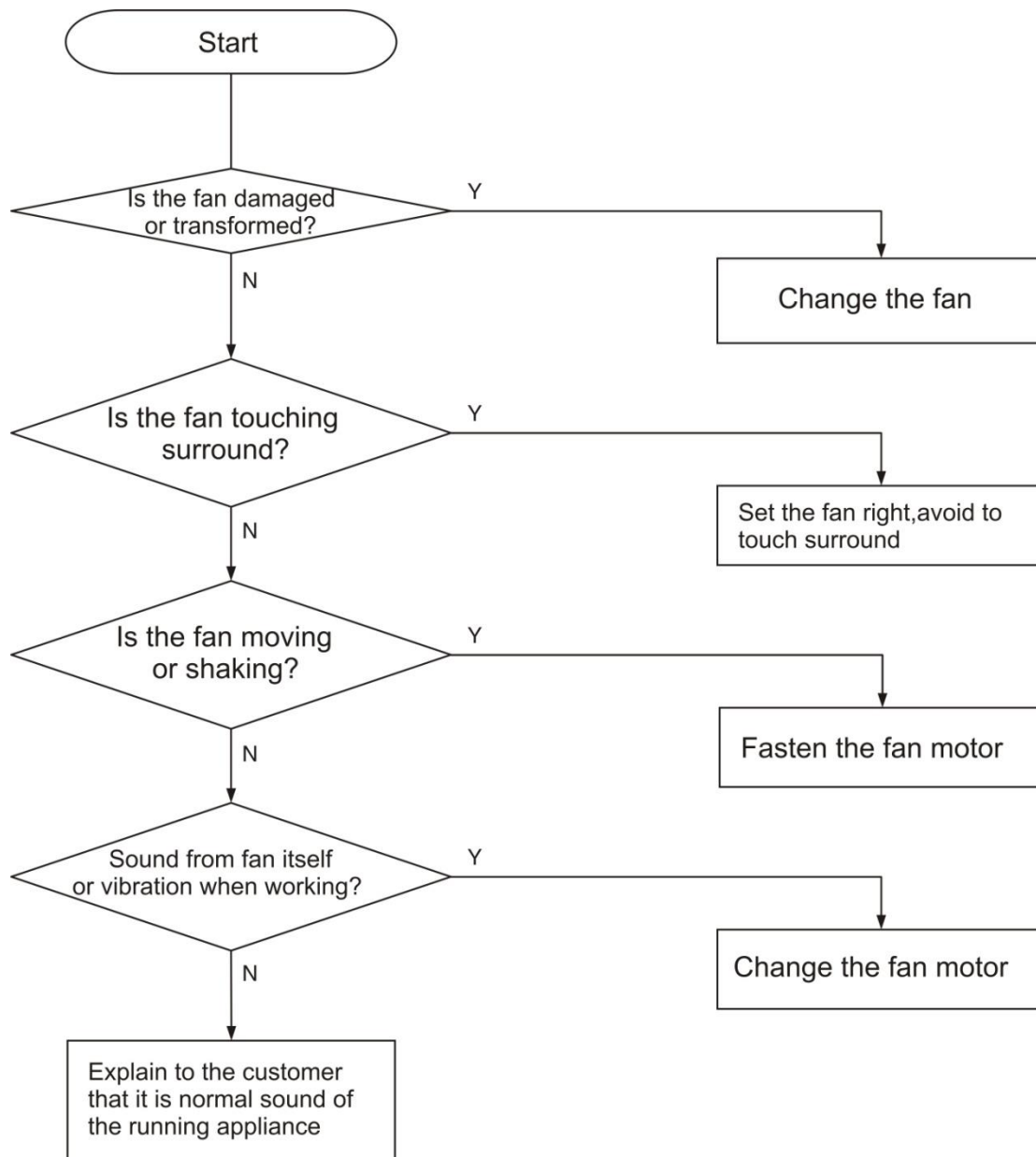

5.7.4 Pipe noise

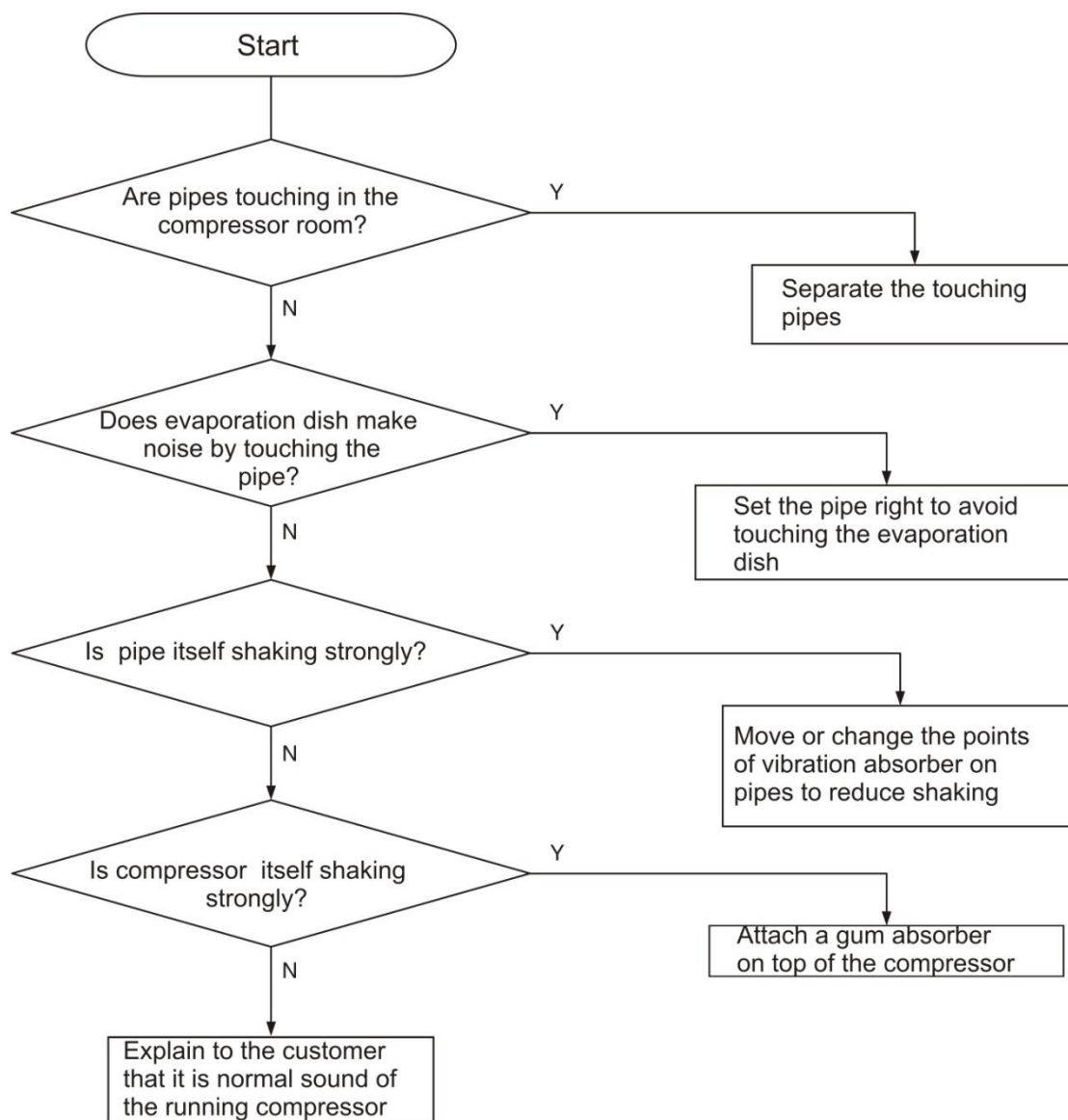

6. Circuit and checking

6.1 Circuit diagram

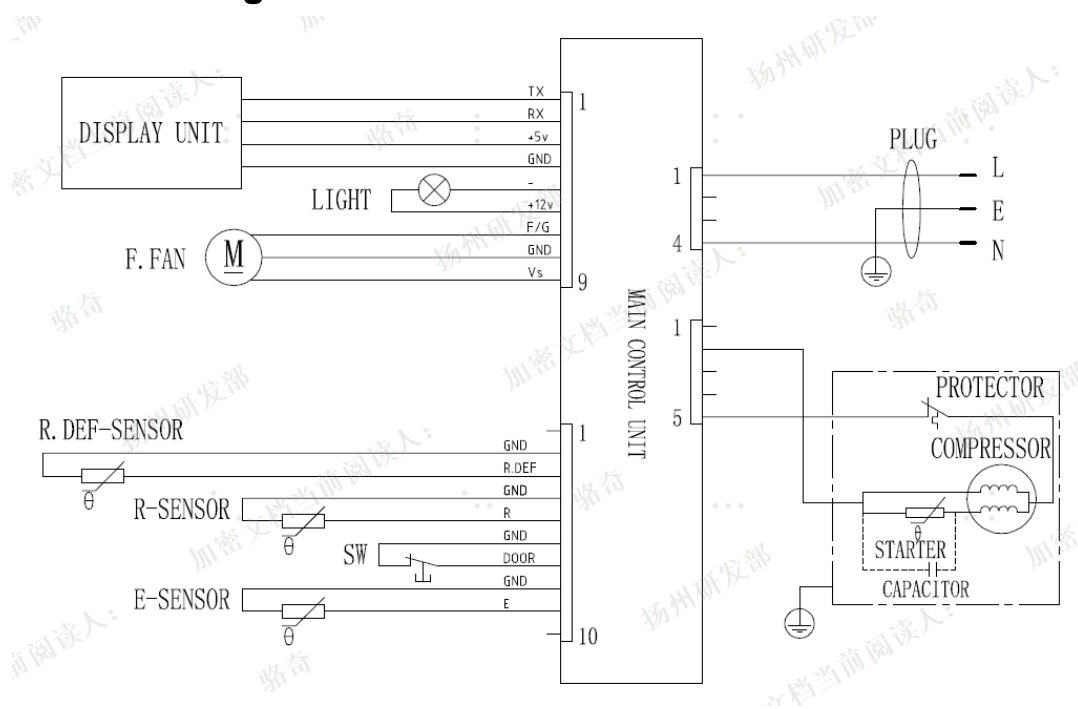

6.2 Main control board

6.2.1 Checking method

If the problem is probably caused by main control board, change it directly to confirm.

6.2.2 Removing the main control board

1. Unplug the appliance.
2. Remove the screw by screwdriver and remove the electric box, as picture 1
3. Remove the electric box cover, as picture 2.
4. Unplug the terminals on the main control board, as picture 3
5. Remove the mainboard and take it out, as picture 4.

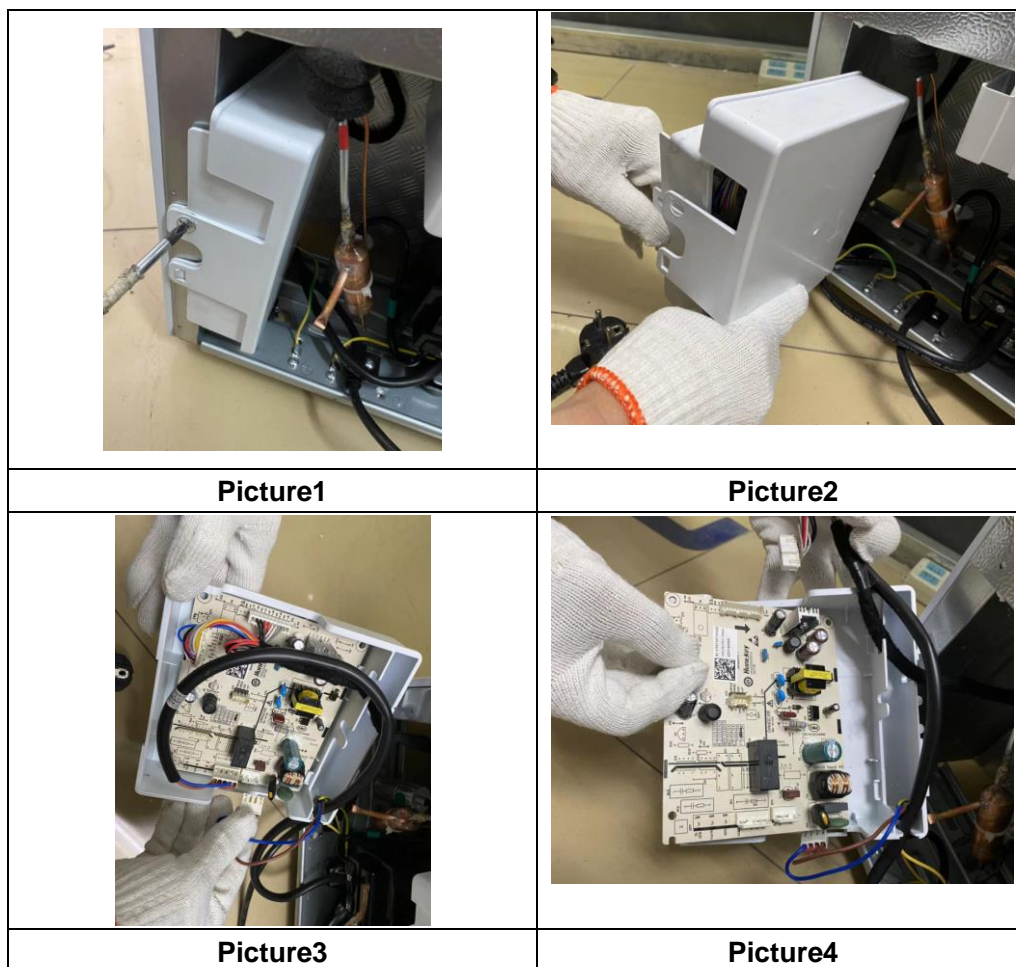

6.3 Compressor

6.3.1 Basic parameters

Input voltage:220~240V

Input frequency:50Hz

6.3.2 Checking method

- 1.Compressor will start 10 seconds after power-on, if it starts unsuccessfully, remove the electric box cover and check.
- 2.Check the connecting wiring between compressor and main control board and repair if it is broken.
- 3、 Use a multimeter to measure voltage between pin No.2 and No.5 on XP7 connector of main control board; If the voltage equal to electric supply power, it means the main control board is OK, to change the Compressor , otherwise change the main control board.

6.3.2.1 Compressor checking

Use a multi-meter to test the resistance between C & S, M&S and M&C :

Normal range of C&S : About $6.8 \pm 7\% \Omega$

Normal range of M&S : About $6.8 \pm 7\% \Omega$

Normal range of M&C : About $6.8 \pm 7\% \Omega$

If the test result is not in this range then it means the inner coil has some problem and the compressor cannot work properly.



Hisense Refrigerator

6.3.3 Removing the PTC starter and overload protector

6.3.3.1 Circuit and checking

1. Unplug the appliance
2. Remove the screws of protector box by screwdriver, as picture 1.
3. Pry up the protector box from top by screwdriver, as picture 2.
4. Unplug the overload protector, as picture 3.
5. Unplug the PTC starter, as picture 4.

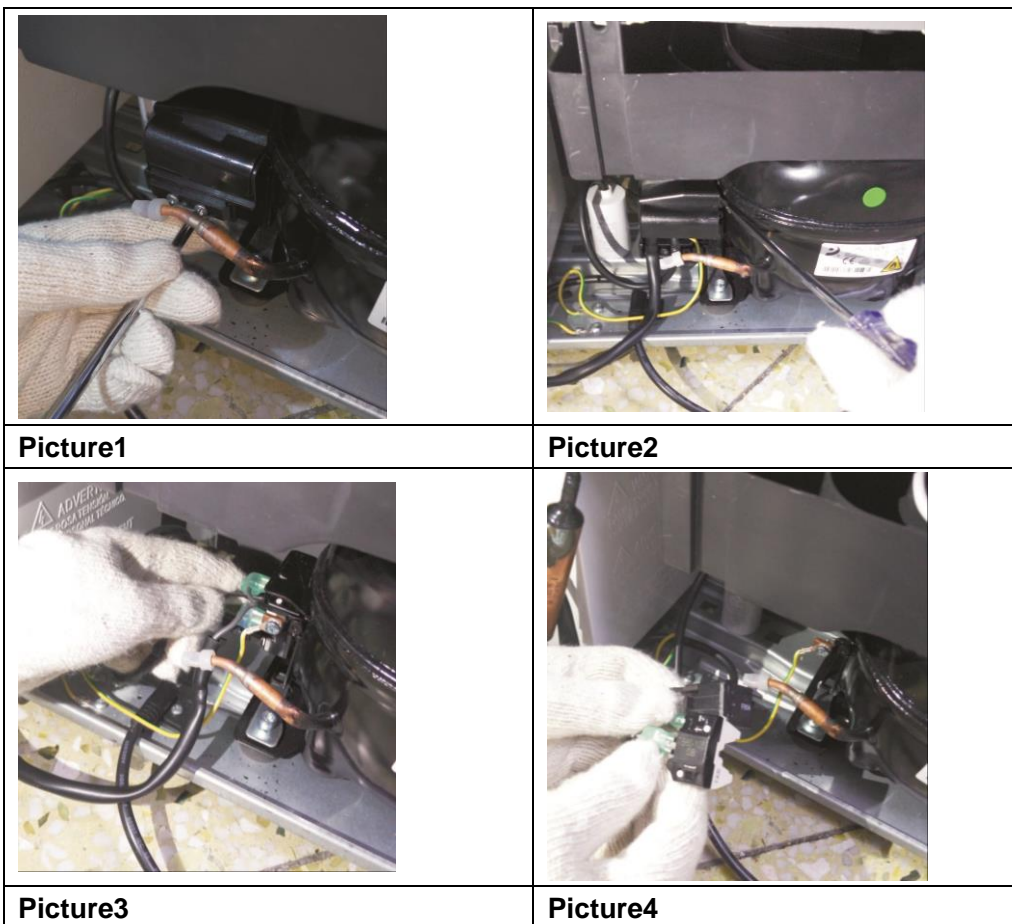

6.4 Fan motor

6.4.1 Basic parameters

6.4.1.1 Refrigerator Fan motor (R. Fan motor)

Rated voltage: DC12V

Rated input power: <2.51W

6.4.2 Checking method [Refrigerator Fan motor (R. Fan motor)]

1. Check the connecting wiring of fan motor is well or not, repair if it is broken. The fridge fan motor corresponding pin No.7~9 on XP2 connector of mainboard.
2. Pin No.9 connect 12V power and pin No.8 connect GND. If the fridge (refrigerator) fan motor works normally, change the mainboard; If not, change the fan motor.

6.4.4 Removing the fan motor and the sensor

6.4.4.1 Removing the fridge fan motor

1. Unplug the appliance.
2. Remove the fridge door and remove the drawers and ice tray as picture 1.
3. Remove the screws by screwdriver as picture 2.
4. Unplug the terminal as picture 3 and remove the wind channel component as picture 4.
5. Tear the tape around the wind channel component, open the buckles then separate two part of the wind channel component as picture 5 and 6.
6. Remove the screws by screwdriver as picture 7 and pull out the fan motor and the sensor as picture 8 and 9.

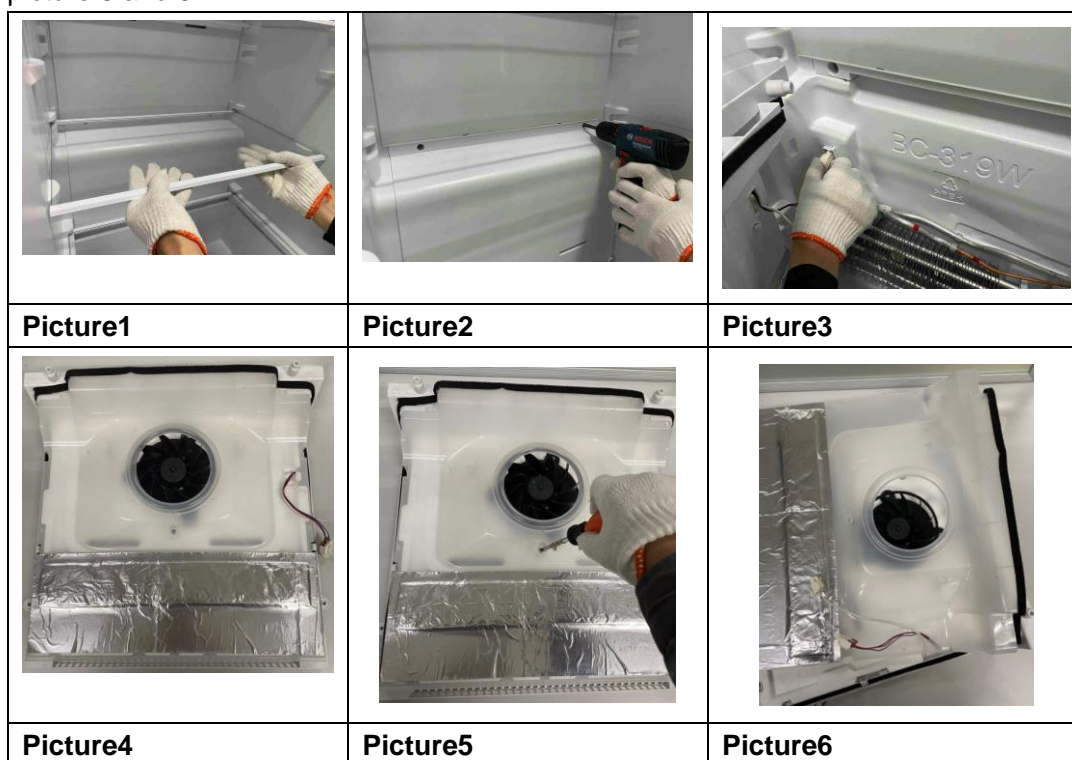

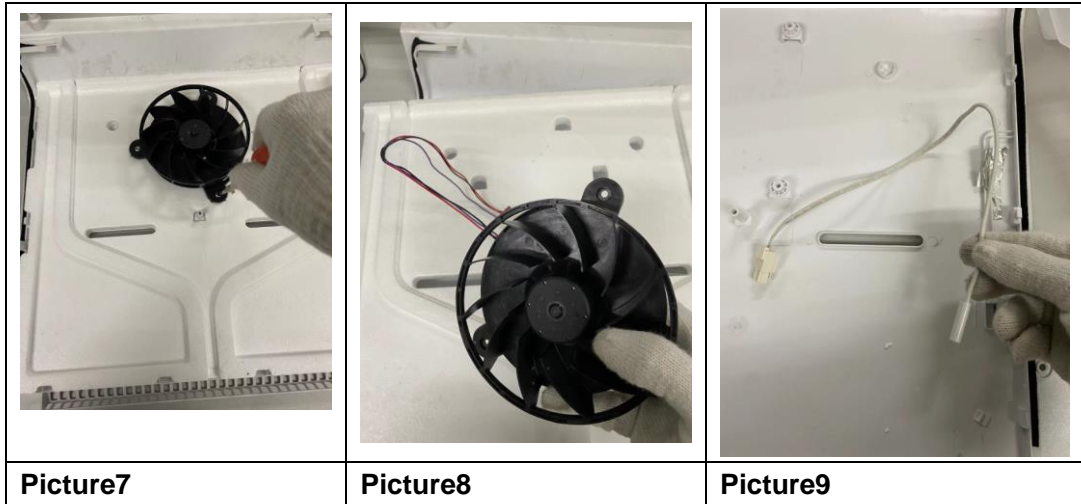

6.5 Light

6.5.1 Basic parameters

Rated voltage: DC12V

Rated power: 1.5 W

6.5.2 Checking method

1. Check the connecting wiring between light and main control board is well or not, repair if it is broken. Refrigerator light corresponding pin No.5 and No.6 on XP2 connector of mainboard.
2. Check output voltage corresponding light of the main control board, if it is 12V, it means the mainboard is OK, change the light; If not, it means the main control board is broken, change it.

6.5.3 Removing the light

1. Unplug the appliance
2. Pry up the light cover with a pin or other spikers as picture 1.
3. Catch the light cover with one hand and pull down it as picture 2.
4. Take the LED light out and unplug the terminal as picture 3 and 4

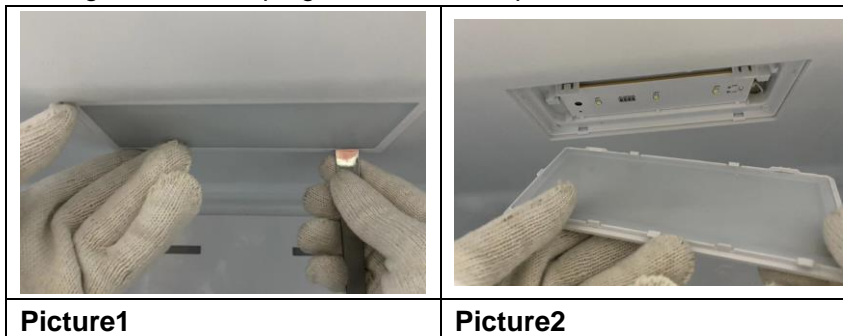



6.6 Display panel

6.6.1 Basic parameters

Input voltage:5V

6.6.2 Checking method

1. Display panel will lighten as soon as power-on, if it light unsuccessful, remove the display panel box cover and check.
2. Check the connecting wiring between display panel and main control board and repair if it is broken.
3. Use a multimeter to measure voltage between pin No.3 and No.4 on XP2 connector of main control board, If the voltage equal to 5V, it means the display panel is broken, change it; If not, change the main control board.

6.6.3 Removing the display panel

1. Unplug the appliance.
2. Pry up the the display panel with a pin or other spikers as picture 1.
3. Take the display panel out and unplug the terminal as picture 2 and 3 .

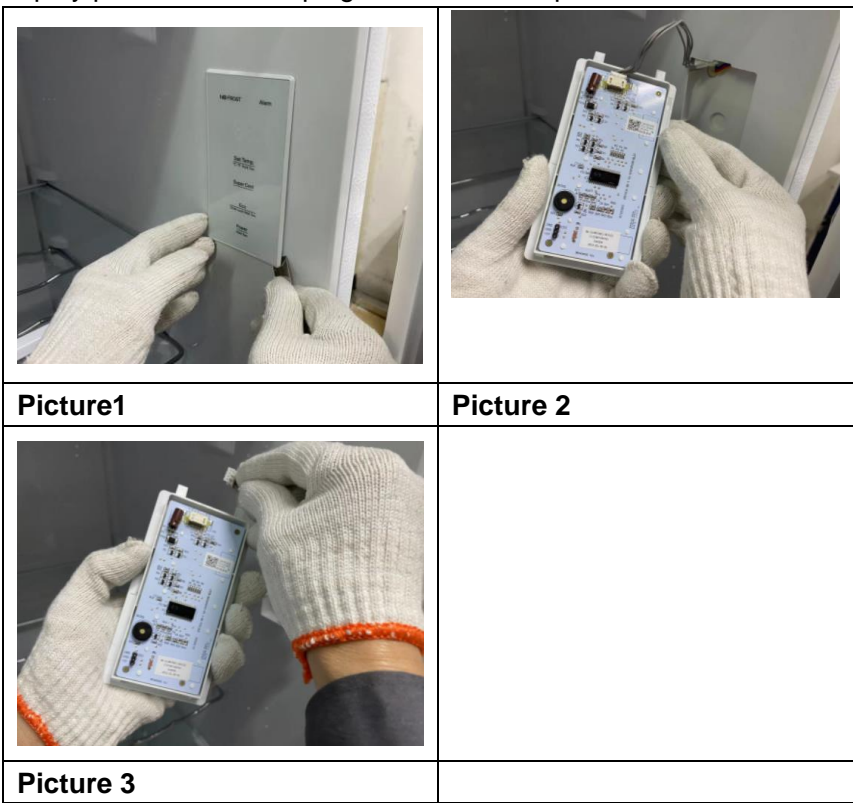

6.7 Sensor

Measuring the sensor resistance

Use a multimeter with the ohm switch to measure the resistor of sensor.

You'd better measure the following temperature resistance is more accurate, and more likely to get the temperature. Normally at surrounding -18°C , 5°C , 25°C , the corresponding resistance is about 17kohm, 5kohm, 2kohm. If the measured value is not within the normal scope, the sensor is bad and needs to repair or change.

6.8 Removing the door switch

6.8.1. Unplug the appliance

6.8.2. Insert the screwdriver into the gap between door switch and cabinet from upside, as picture 1.

6.8.3. Pry up the door switch by the screwdriver, as picture 2.

6.8.4. Pry up the door switch from underneath too, as picture 3.

6.8.5. Hold the door switch and pull it out, as picture 4.

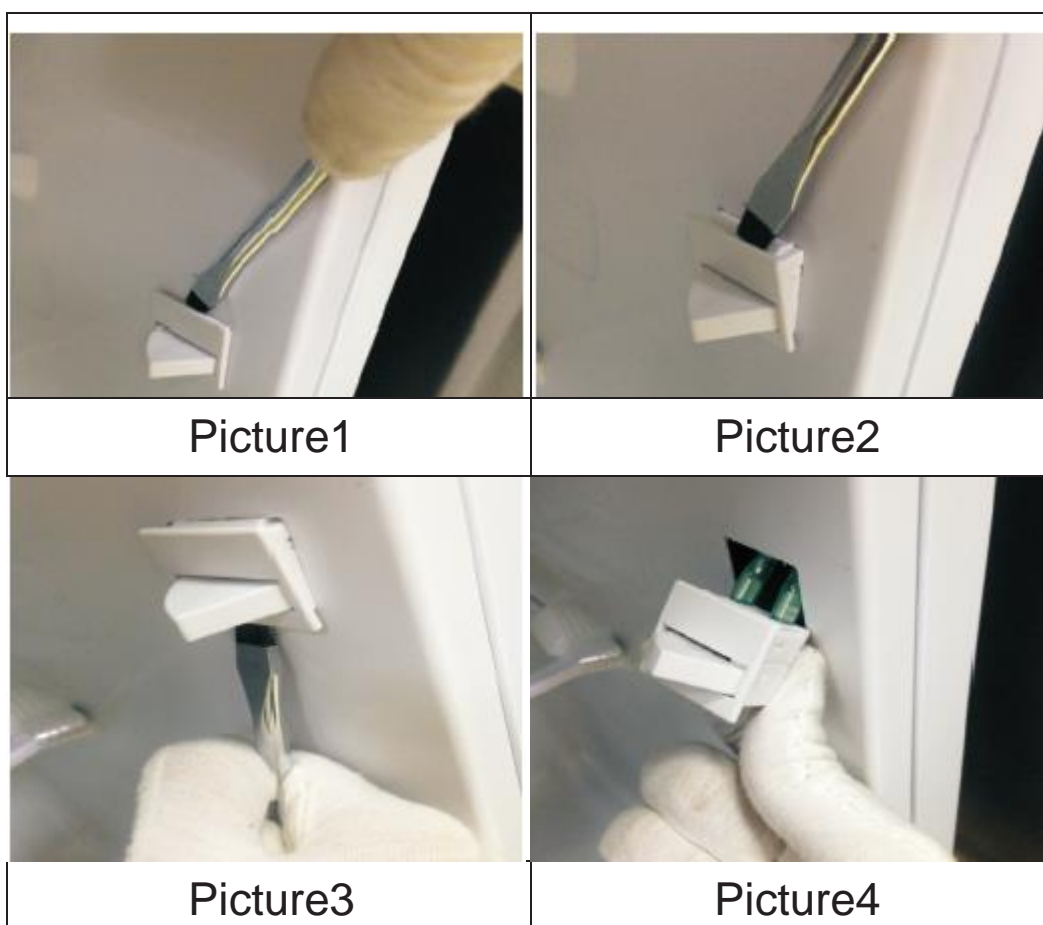

6.9 Removing environment temperature sensor unit

1. Unplug the appliance.
2. Using a screwdriver to pry the right upper hinge cover, as picture 1.
3. Take out the environment temperature sensor unit, as picture 2.

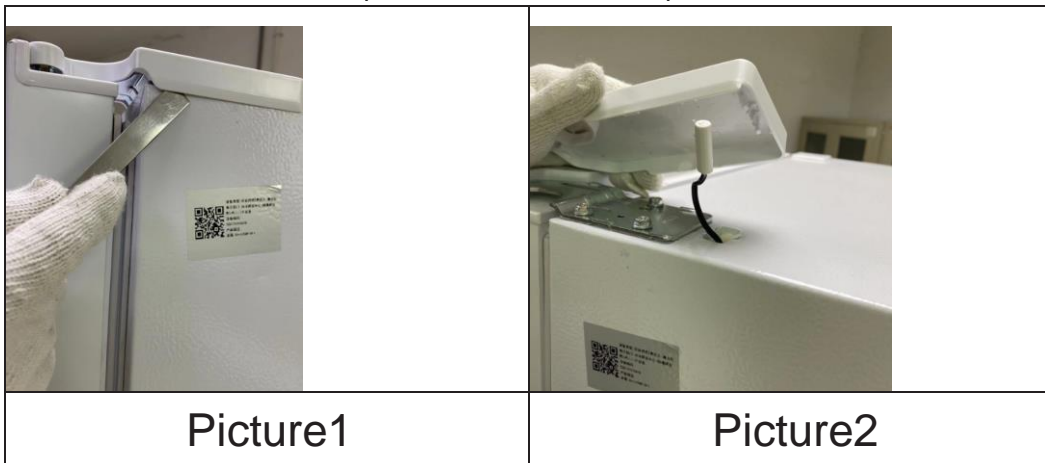

7. Cooling system repairing

7.1 Refrigeration system

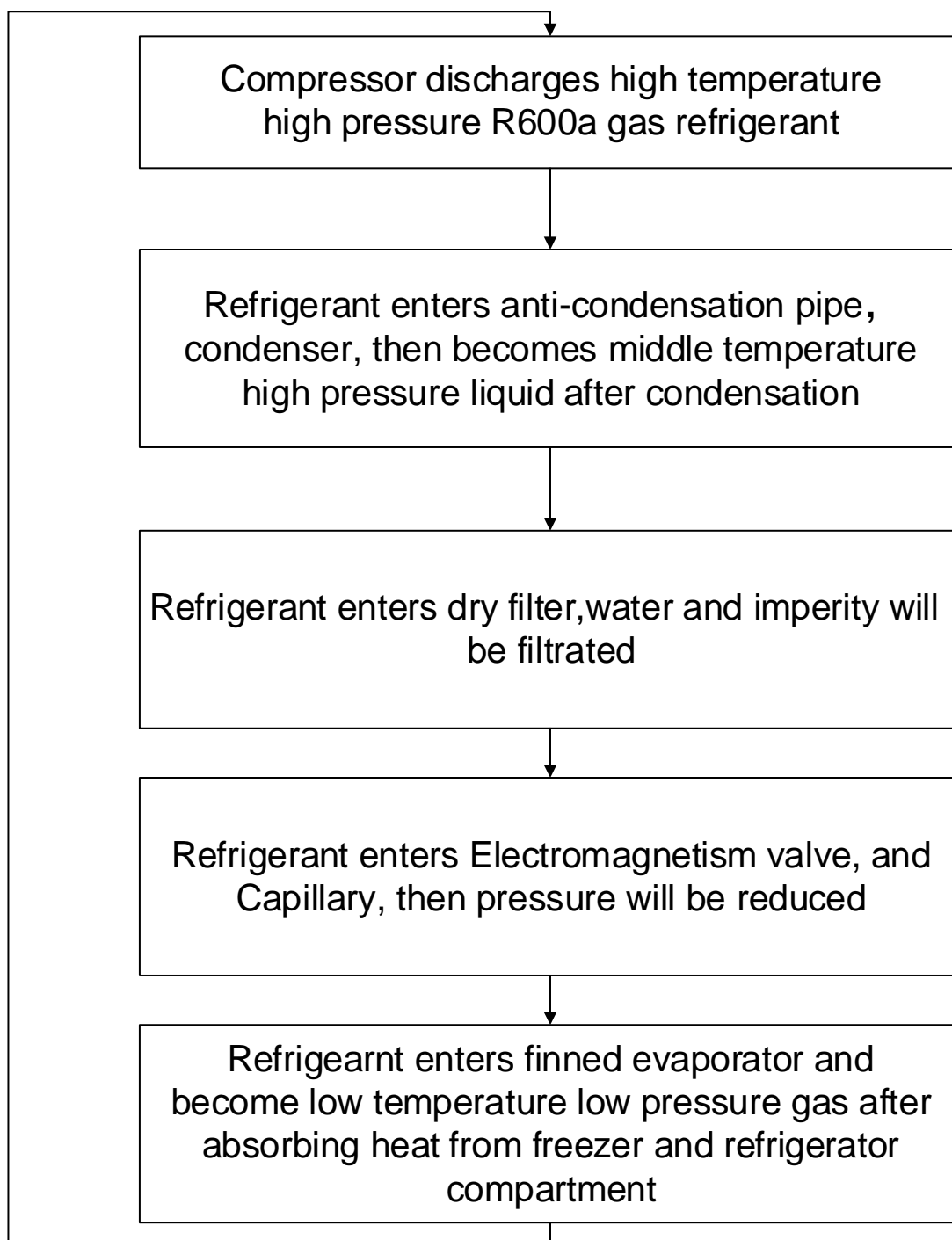

7.2 Summary of repair

Process	Contents	Tools
Remove refrigerant Residuals	* Cut charging pipe ends (Comp. & Dryer) and discharge refrigerant from drier and compressor.	* Nipper, side cutters
Parts replacement and welding	* Confirm refrigerant (R-134a or R-600a) and oil for compressor and drier. * Confirm N2 sealing and packing conditions before use. Use good one for welding and assembly. * Repair in a clean and dry place.	* Pipe Cutter, Gas welder, N2 gas
Vacuum	* Evacuate for more than forty minutes after connecting manifold gauge hose and vacuum pump to high (drier) and low (compressor) pressure sides.	* Vacuum pump , Manifold gauge.
Refrigerant charging and charging inlet welding	* Weigh and control the bombe in a vacuum conditions with electronic scales and charge through compressor inlet (Process tube). * Charge while refrigerator operates). * Weld carefully after inlet pinching.	* Bombe (mass cylinder), refrigerant manifold gauge, electronic scales, punching off flier, gas welding machine
Check refrigerant leak and cooling capacity	* Check leak at weld joints. Note :Do not use soapy water for check. * Check cooling capacity → Check condenser manually to see if warm. → Check hot pipe manually to see if warm. → Check frost formation on the whole surface of the evaporator.	* Electronic Leak Detector, Driver.
Compressor compartment and tools arrangement	* Remove flux from the silver weld joints with soft brusher wet rag. (Flux may be the cause of corrosion and leaks.) *Clean tools and store them in a clean tool box or in their place.	* Copper brush, Rag, Tool box
Transportation and installation	* Installation should be conducted in accordance with the standard installation procedure. (Leave space of more than 5 cm from the wall for compressor compartment cooling fan mounted model.)	

7.3 Regulation of repair

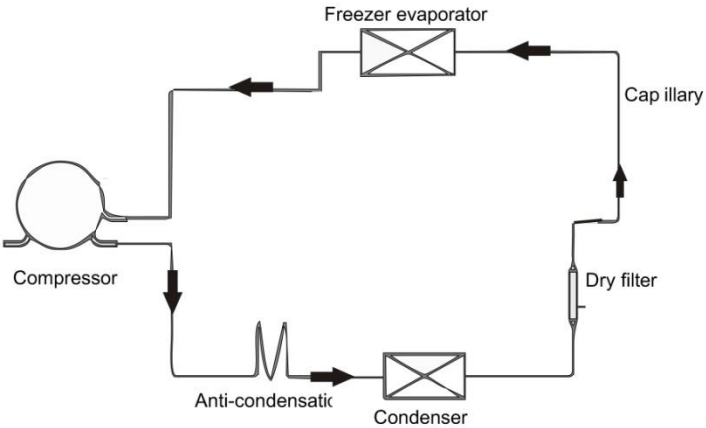
Items	Precautions
Use of tools.	1) Use special parts and tools for R-134a or R-600a
Removal of retained refrigerant.	<p>1) Remove retained refrigerant more than 5 minutes after turning off a refrigerator. (If not, oil will leak inside.)</p> <p>2) Remove retained refrigerant by cutting first high pressure side (drier part) with a nipper and then cut low pressure side. (If the order is not observed, oil leak will happen.)</p> 
Replacement of drier.	1) Be sure to replace drier when repairing pipes and injecting refrigerant.
Nitrogen blowing welding.	1) Weld under nitrogen atmosphere in order to prevent oxidation inside a pipe. (Nitrogen pressure : 0.1~0.2 kg/cm2.)
Others.	<p>1) Nitrogen only should be used when cleaning inside of cycle pipes inside and sealing.</p> <p>2) Check leakage with an electronic leakage tester.</p> <p>3) Be sure to use a pipe cutter when cutting pipes.</p> <p>4) Be careful not the water let intrude into the inside of the cycle.</p>

7.4 Practical work of repair

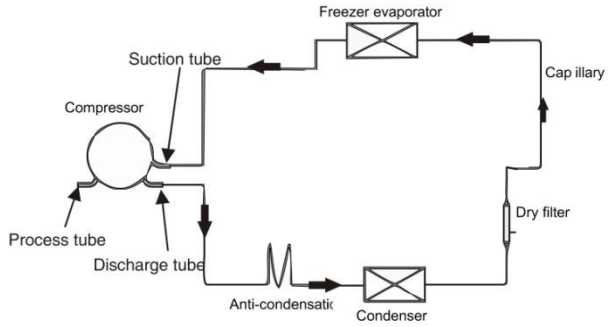
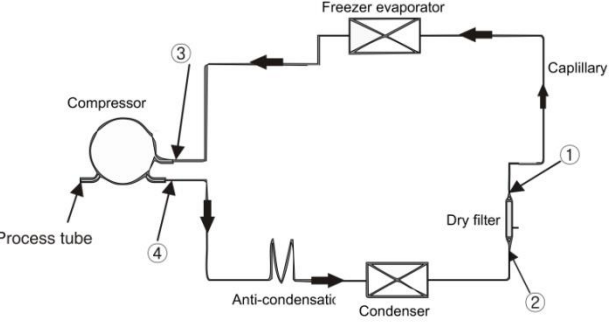
Items	Precautions
<p>1. Removal of residual refrigerant.</p>	<p>1) Remove residual refrigerant more than 5 minutes later after turning off the refrigerator. (If not, compressor oil may leak inside.) 2) Remove retained refrigerant slowly by cutting first high pressure side (drier part) with a nipper and then cut low pressure side.</p> 
<p>2. Nitrogen blowing welding.</p>	 <p>* When replacing a drier: Weld 1 and 2 parts by blowing nitrogen (0.1~0.2kg/cm²) to high pressure side after assembling a drier.</p> <p>* When replacing a compressor: Weld 3 and 4 parts by blowing nitrogen to the low pressure side. Note) For other parts, nitrogen blowing is not necessary because it does not produce oxidized scales inside pipe because of its short welding time.</p> <p>- KEYPOINTING Welding without nitrogen blowing produces oxidized scales inside a pipe, Which affect on performance and reliability of a product.</p>

7.4 Practical work of repair

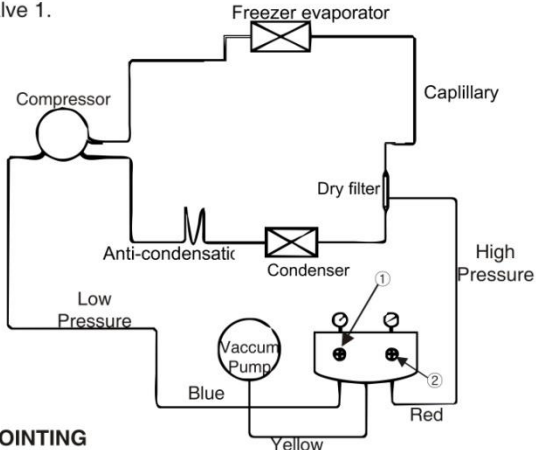
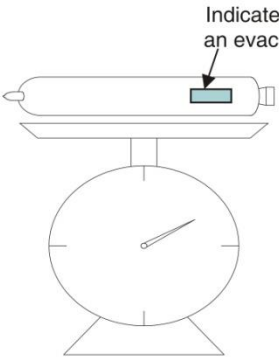
Items	Precautions
<p>3.Vacuum degassing.</p>	<p>* Pipe Connection Connect a red hose to the high pressure side and a blue hose to the low pressure side.</p> <p>* Vacuum Sequence Open 1,2 valves and evacuate for 40 minutes. Close valve 1.</p>  <p>※ KEYPOINTING</p> <ol style="list-style-type: none"> 1) If power is applied during vacuum degassing, vacuum degassing shall be more effective. 2) Operate compressor while charging refrigerant. (It is easier and more certain to do like this.)
<p>4.Refrigerant charging.</p>	<p>* Charging sequence</p> <ol style="list-style-type: none"> 1) Check the amount of refrigerant supplied to each model after completing vacuum degassing. 2) Evacuate bombe with a vacuum pump. 3) Measure the amount of refrigerant charged. <ul style="list-style-type: none"> - Measure the weight of an evacuated bombe with an electronic scale. - Charge refrigerant into a bombe and measure the weight. Calculate the weight of refrigerant charged into the bombe by subtracting the weight of an evacuated bombe.  <p>- KEYPOINTING</p> <ol style="list-style-type: none"> 1) Be sure to charge the refrigerant at around 25C. 2) Be sure to keep -5g in the winter and +5g in summer. <div style="border: 1px solid black; padding: 5px; margin-top: 10px;"> <p>Calculation of amount of refrigerant charged</p> <p>the amount of refrigerant charged = a weight after charging - a weight before charging (a weight of an evacuated cylinder)</p> </div>

7.5 Brazing reference drawing

