



**Hisense**

# Refrigerator

# Service Manual

**Model:**

RS-47WL4SIB/CV1-001

## Contents

<b>1.Warnings and precautions for safety</b> .....	<b>1</b>
<b>2.Appearance and structure</b> .....	<b>2</b>
2.1 View of the appliance .....	2
2.2 Wind channel structure .....	3
2.3 Fridge evaporator structure .....	4
2.4 Compressor room structure.....	5
<b>3.Basic parameters</b> .....	<b>6</b>
<b>4.Operation and functions</b> .....	<b>7</b>
4.1 Display controls.....	7
4.2 Reversing the door.....	9
4.3 Error Code .....	12
<b>5.Troubleshooting</b> .....	<b>13</b>
5.1 Common problem and checking.....	13
5.2 Faulty start .....	15
5.3 Refrigeration failure.....	16
5.4 Thick frost in freezer compartment .....	19
5.5 Dew in refrigerator compartment.....	20
5.6 Breaking of light .....	21
5.7 Noise.....	22
<b>6.Circuit and checking</b> .....	<b>26</b>
6.1 Circuit diagram.....	26
6.2 Mainboard.....	26
6.3 Compressor .....	27
6.4 Fan motor .....	30
6.5 Light.....	31
6.6 Display panel .....	32
6.7 Sensor .....	33
6.8 Door switch .....	33
<b>7.Cooling system repairing</b> .....	<b>34</b>
7.1 Refrigeration system .....	34
7.2 Summary of repair.....	35
7.3 Regulation of repair.....	36
7.4 Practical work of repair.....	37
7.5 Brazing reference drawing .....	39



## 1. Warning and precautions for safety

Please observe the following safety precautions in order to use safely and correctly the refrigerator and to prevent accident and danger during repair.

1. Be care of an electric shock. Disconnect power cord from wall outlet and wait for more than three minutes before replacing PCB parts. Shut off the power whenever replacing and repairing electric components.
2. When connecting power cord, please wait for more than five minutes after power cord was disconnected from the wall outlet.
3. Please check if the power plug is pressed down by the refrigerator against the wall. If the power plug was damaged, it may cause fire or electric shock.
4. If the wall outlet is over loaded, it may cause fire. Please use its own individual electrical outlet for the refrigerator.
5. Please make sure the outlet is properly earthed, particularly in wet or damp area.
6. Use standard electrical components when replacing them.
7. Make sure the hook is correctly engaged. Remove dust and foreign materials from the housing and connecting parts.
8. Do not fray, damage, machine, heavily bend, pull out or twist the power cord.
9. Please check the evidence of moisture intrusion in the electrical components. Replace the parts or mask it with insulation tapes if moisture intrusion was confirmed.
10. Do not touch the ice maker with hands or tools to confirm the operation of geared motor.
11. Do not let the customers repair, disassemble and reconstruct the refrigerator for themselves. It may cause accident, electric shock, or fire.
12. Do not store flammable materials such as ether, benzene, alcohol, chemicals, gas, or medicine in the refrigerator.
13. Do not put flower vase, cup, cosmetics, chemicals, etc., or container with full of water on the top of the refrigerator.
14. Do not put glass bottles with full of water into the freezer. The contents shall freeze and break the glass bottles.
15. When you scrap the refrigerator, please disconnect the door gasket first and scrap it.

## 2. Appearance and structure

### 2.1 View of the appliance

BCD-355WYD/HC4(E) RS-47WL4SIB/CV1-001

1. Cabinet
2. Up LED light
3. Right LED light(optional)
4. Glass shelf
5. Bottle rack
6. Small glass shelf
7. 0°C cool plus
8. Crisper cover
9. Crisper box
10. Adjustable bottom feet
11. Upper shelf
12. Egg rack(inside)
13. Storage box(optional)
14. Middle rack
15. Water storage box part
16. Handle
17. Bottle holder(inside)(optional)
18. Lower rack
19. Fridge door
20. Fridge gasket

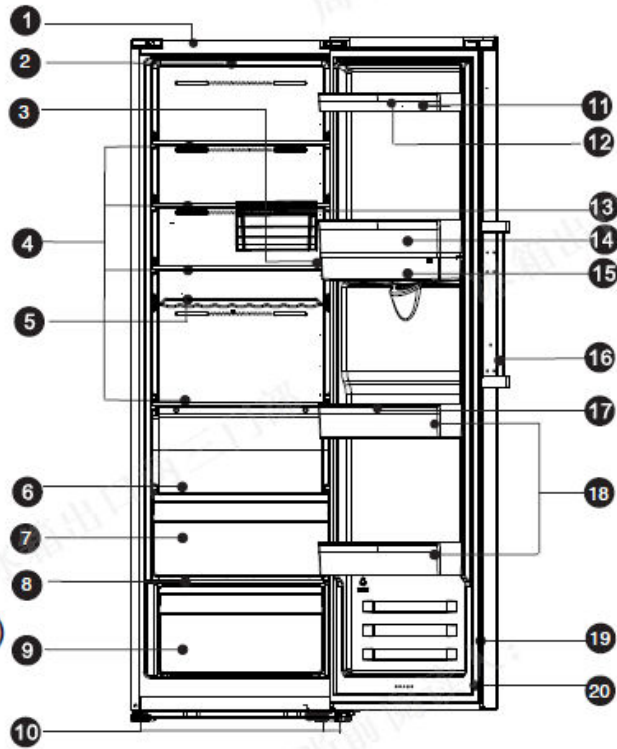

**Note:** Due to unceasing modification of our products, your refrigerator may be slightly different from this instruction manual, but its functions and using methods remain the same. To get more space in the freezer, you can remove drawers (except lower freezer drawer), ice tray.

## 2.2 Wind channel structure

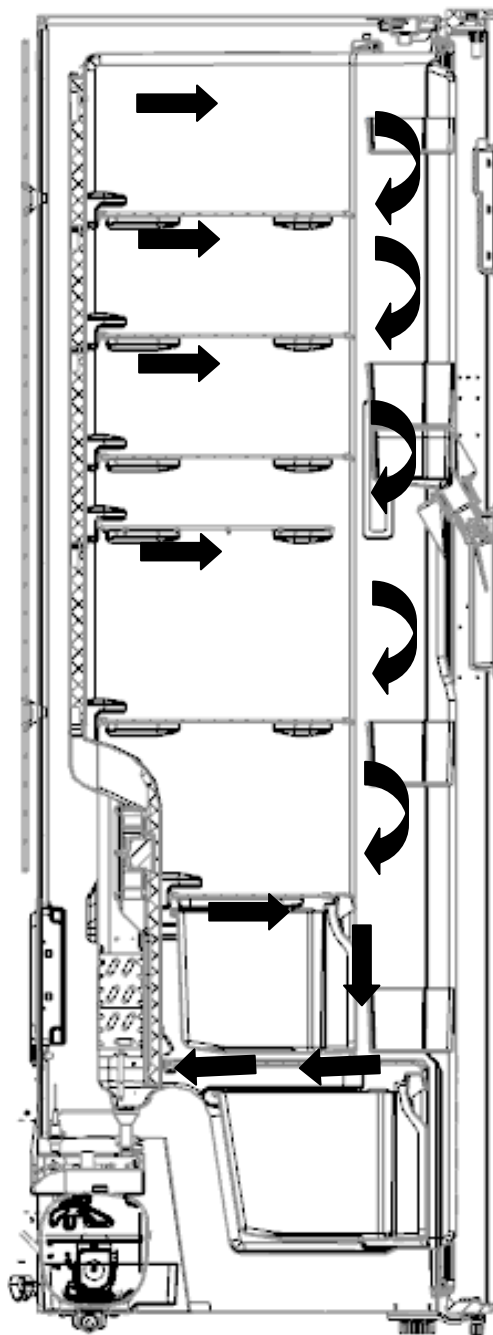

## 2.3 Fridge evaporator structure

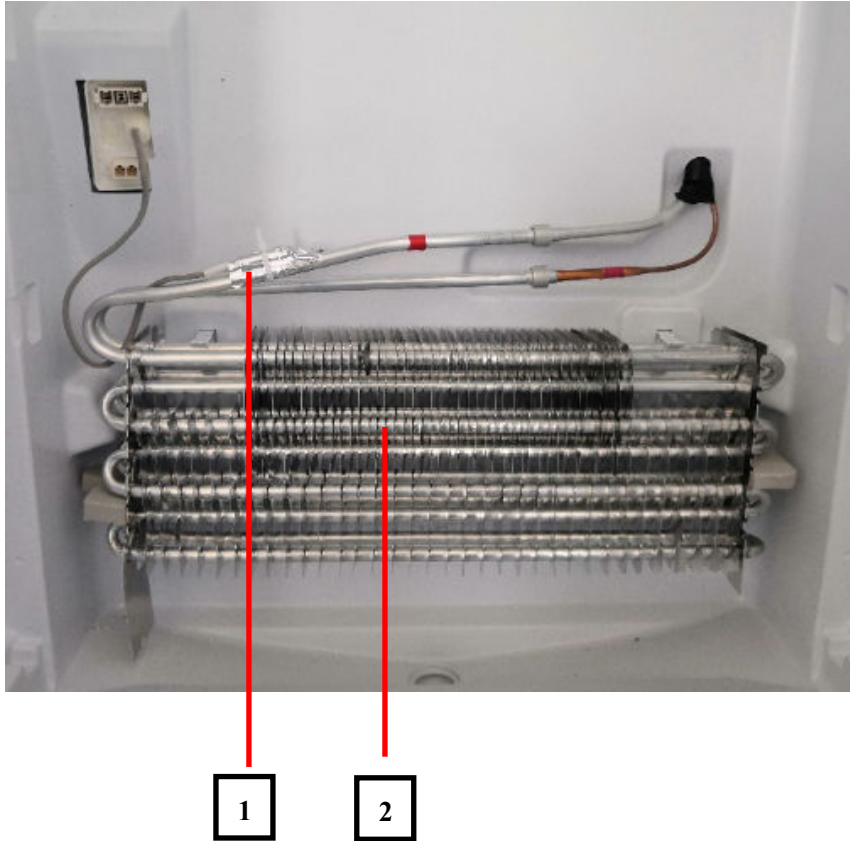

1. Temperature sensor part
2. Wing slice evaporator part



## 2.4 Compressor room structure

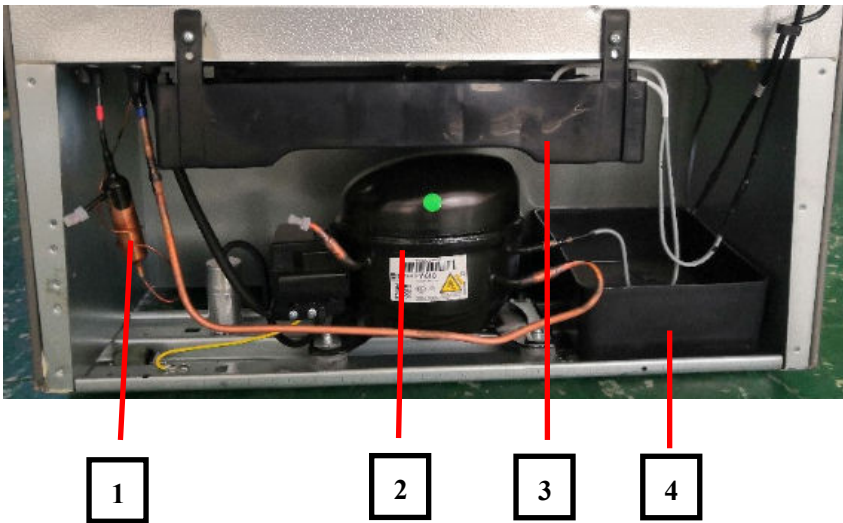

1. Dry filter
2. Compressor
3. Evaporating Dish Part
4. Evaporating Dish Part

### 3. Basic parameters

#### BC-355WYD/HC4(E)- RS-47WL4SIB/CV1-001

Content	Unit	Value
Voltage/frequency		220-240V / 50Hz
Storage volume (fridge)	L	370
Climate class		SN/N/ST/T
Energy consumption / year	kWh/year	179
Energy consumption (EN153) per 24 h	kWh/24 h	0.490
Kind of coolant /Charge ( 134 /R600a) / grammes	R / g	R600a/46
Foaming components (R141b/C-P)	PU/	C-P
Certifications ( CE / ISO 9001/2 / LGA etc.)		CE+CB+GS
Max noise level	dB(A)	40

## 4. Operation and functions

### 4.1 Display controls

Use your appliance according to the following control regulations, your appliance has the corresponding functions and modes as the control panels showed in the pictures below. When the appliance is powered on for the first time, the backlighting of the icons on display panel starts working. If no buttons have been pressed and the doors are closed, the backlighting will turn off.



#### Controlling the temperature

For optimum food preservation, We recommend that when you start your refrigerator for the first time, the temperature for the refrigerator is set to 4°C. If you want to change the temperature, follow the instructions below.

**Caution!** When you set a temperature, you set an average temperature for the whole refrigerator cabinet. Temperatures inside each compartment may vary from the temperature values displayed on the panel, depending on how much food you store and where you place them. Ambient temperature may also affect the actual temperature inside the appliance. Note: High temperature setting will accelerate food waste.

#### 1. Temp.

In the unlocked state, press "Temp." button, the fridge zone indicator blinks, the fridge set temperature is reduced by 1°C, and the fridge temperature is cyclically adjusted between 2°C and 8°C. If you don't continue pressing the button for 10 seconds, the setting takes effect.

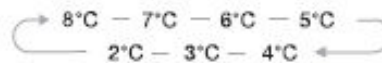

#### 2. Super Cool



Super Cool can refrigerate your food much faster, keeping food fresh for a longer period.

- In the unlocked state, press "Super Cool" button to enter the Super Cool mode, the Super Cool icon is lit and the temperature is set to 2°C.
- Super Cool mode automatically exits after 3 hours.
- When Super Cool function is on, you can switch it off by pressing "Temp." button and the refrigerator temperature setting will revert back to the previous setting.

#### 3. Holiday



If you are going to be away for a long period of time, you can turn it to Holiday mode to save on electricity.

- In the unlocked state, press "Super Cool" button to enter the Holiday mode, the Holiday icon is lit and the temperature is set to "15°C".

**Important!** Do not store any food in the fridge during this time.

- When the Holiday function is on, you can switch it off by pressing "Temp." button. The fridge temperature setting will revert back to the previous setting.

#### 4. Alarm



In case of alarm, "Alarm" icon will be flashing and there will be buzzing sound. In the unlocked state, press the "Alarm" button at this time to release the door alarm, the buzzer stops beeping, the alarm icon is always lit, and the display screen shows normal.

##### Door Alarm

- When the door is open for over 1 minutes, the door alarm will sound, meanwhile the display panel show "dr". In case of door alarm, buzzer will sound 3 times every 1 min.
- After the door alarm time exceeds more than 10 minutes, the buzzer stops beeping, the alarm icon is off, and the display screen shows normal.
- To save energy, please avoid keeping the door open for a long time when using the appliance. The door alarm can also be cleared by closing the door.

#### 5. Standby



If you want to clean the appliance or stop using it, you can turn the appliance off by pressing "  " button.

- When the refrigerator is working, you can switch the appliance off by pressing "  " button for 3 seconds, meanwhile the display panel show "OF".

**Important!** Do not store any food in the fridge during this time.

- When the refrigerator is in standby mode and unlocked, press the "  " button for 3 seconds, the refrigerator will turn on and the display will show normally.

#### 6. Child Lock



You can press the "Child Lock" button in case children touch the buttons, to avoid wrong set.

When the Child Lock icon is lit, the refrigerator is locked, pressing the other buttons would not work.

- When the Child Lock function is activated, you can switch off this function by pressing "Child Lock" button for 3 seconds, meanwhile "Child Lock" icon will be turned off. At this time, you can operate the mode and set the temperature, cancel the alarm, standby mode.
- No button operation for about 20 seconds, and the button will be locked automatically.
- No button operation for about 60 seconds, the display will be off and can be resumed by tapping any button at this time.





Note: The display control only can be setted in the unlocked state.

## 4.2 Reversing the door

The side at which the door opens can be changed, from the right side (as supplied) to the left side, if the installation site requires.

**Warning!** When reversing the door, the appliance must not be connected to the mains. Ensure that the plug is removed from the mains socket.

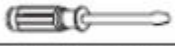
Tools you will need:

	
8mm socket wrench	Cross-shaped screwdriver
	
Thin-blade screwdriver	8mm wrench

**Note:** Before you start lay the refrigerator on its back in order to gain access to the base, you should rest it on soft foam packaging or similar material to avoid damaging the backboard of the refrigerator. To reverse the door, the following steps are generally recommended.

1. Stand the refrigerator upright. Open the door to take out all door racks (to avoid racks damaged) and then close the door.

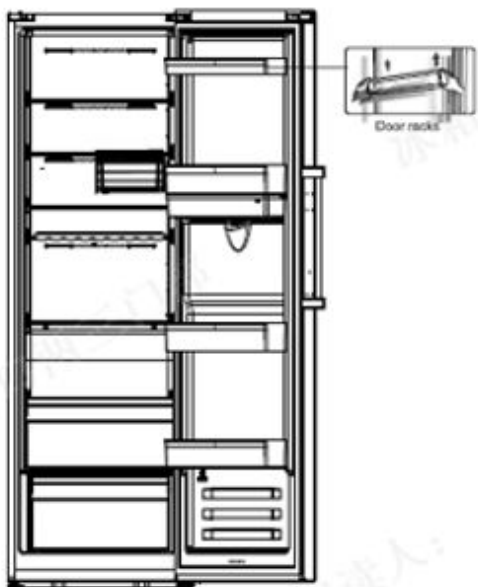

2. Open part ① on top of the refrigerator body from right side and then take down part ③ and part ④ on the door in the same way. Take down part ② and put it back to the plastic bag.

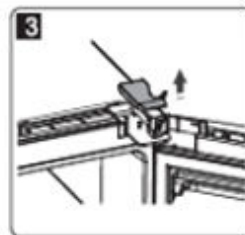
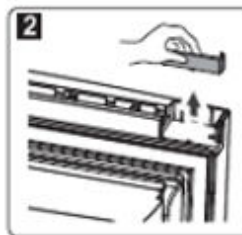
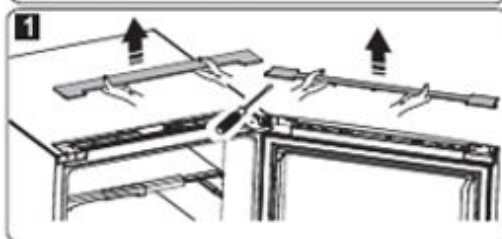
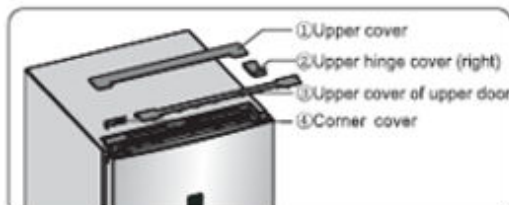

3. Disconnect electrical connector ① as well as electrical connector ② and then take down part ③.

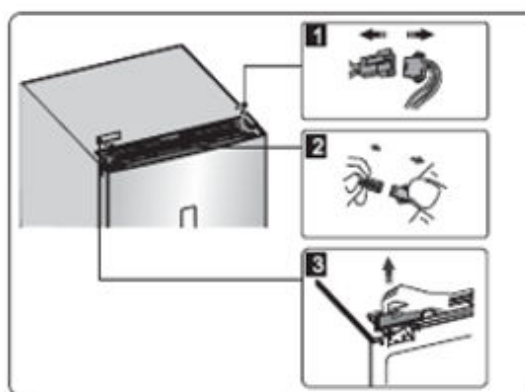

4. Remove the screws ①, loose wire ②, and remove part ③.

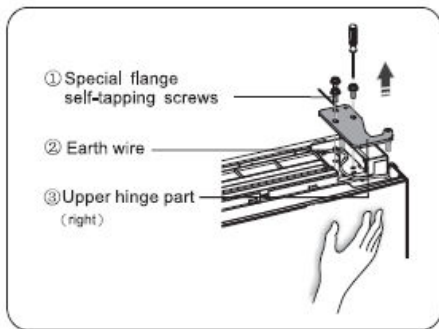

**Note:** Please hold the door by hand during step 4 to prevent door dropping.

5. Remove the door and place it on a smooth surface with its panel upwards. Lever part ① and part ④, then loose screws ②, as shown in the picture. Change handle ③ to the right side, then install screws ②, part ① and part ④ in turn. Loose screws ⑦, detach part ⑥ and part ⑤, turn part ⑥ over and then install part ⑤ and part ⑥ to the left side with screws ⑦.

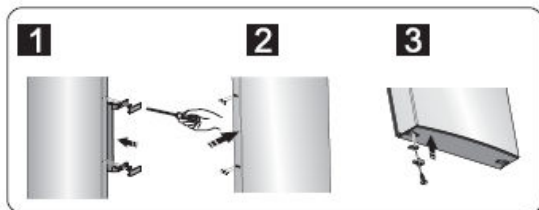
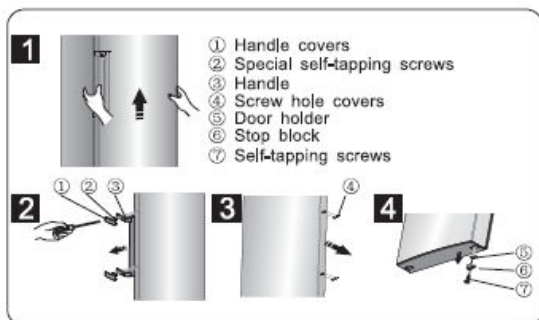

6. Place refrigerator flatwise, remove part ③ and then loose screws ④. Remove part ② and part ①.

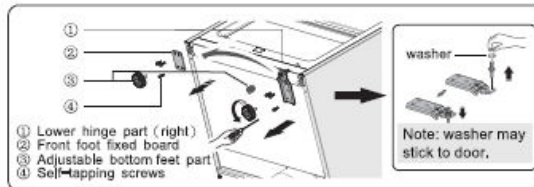

7. Screw out lower hinge, change it to the near hole site, and then screw up and mount washer.

8. Just remount to the step 6, change part ① to left and part ② to right and then fix them with screws ④. Finally install part ③.

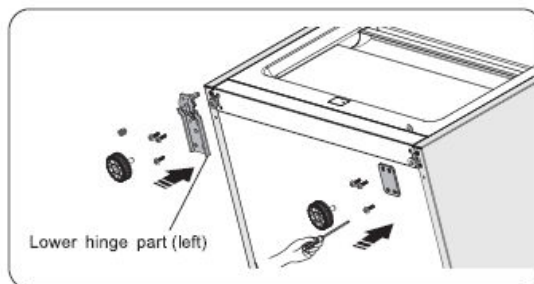

9. Exchange wires both in the left and right slots of refrigerator body.

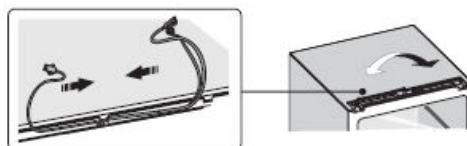

10. Move the door to appropriate position, adjust part① (which is in the plastic bag) and the door, Move the connecting wire② in the slot of the door from right to left , and then fix part① and wire ② by screws③. (Please hold the door by hand when installing)

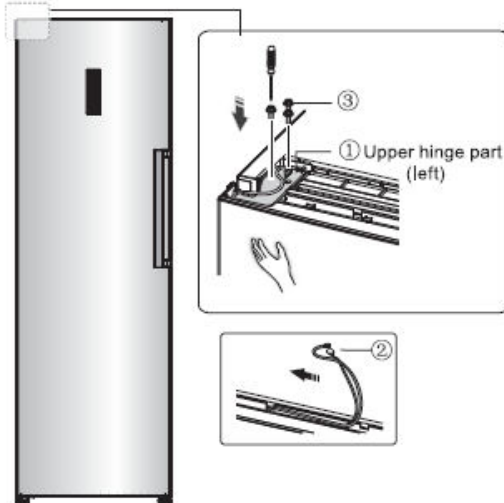

11. Connect electrical connector① in accordance with step 3 and then install part② (which is in the plastic bag).

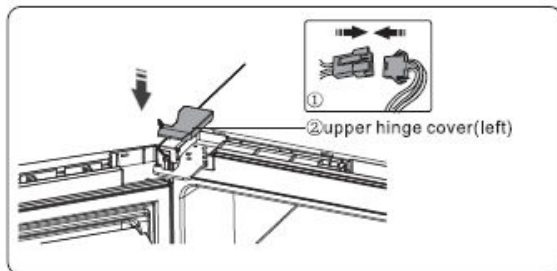

12. Reverse part① by 180° and install it onto the right corner of the door, then mount part②. (both of which are taken down in step 2)

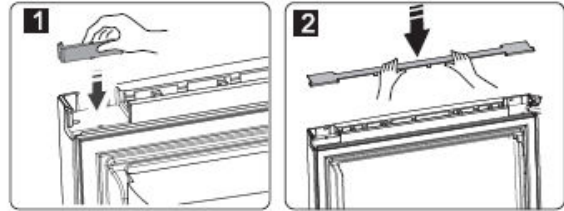

13. Take the reed switch out of the coping block(part③ in step 3) and mount it on another block for use (which is with mark "R" in the plastic bag). Put the coping block just removed back to the plastic bag.

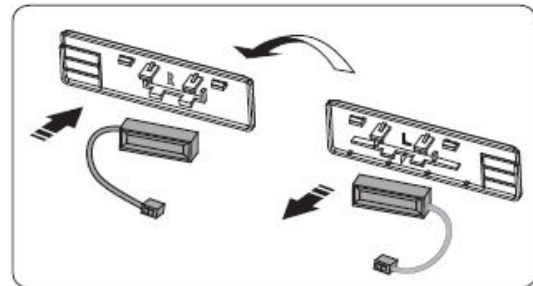

**Note:** Be sure character side of reed switch fits well with coping block.

14. Install part ① , connect the wire connector② , and then install part③ .

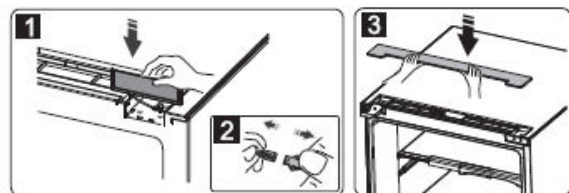

15. Open the door, mount door racks and then close it.

---

### 4.3 Error Code

<b>Code</b>	<b>Problem</b>
<b>E0</b>	Display panel sensor malfunctions
<b>E1</b>	Refrigerator sensor malfunctions
<b>E2</b>	Refrigerator evaporator sensor malfunctions
<b>Ec</b>	Communication sending malfunctions
<b>Er</b>	Communication receiving malfunctions
<b>F2</b>	Refrigerator fan malfunctions
<b>dr</b>	Unclosed Refrigerator doors



## 5. Trouble shooting

### 5.1 Common problem and checking

If you experience a problem with your appliance or are concerned that the appliance is not functioning correctly, you can carry out some easy checks before calling for service, please see below.

**Warning!** Don't try to repair the appliance yourself. If the problem persists after you have made the checks mentioned below, contact a qualified electrician, authorized service engineer or the shop where you purchased the product.

Problem	Possible cause & Solution
Appliance is not working correctly	Check whether the power cord is plugged into the power outlet properly.
	Check the fuse or circuit of your power supply, replace if necessary.
	It is normal that the freezer is not operating during the defrost cycle, or for a short time after the appliance is switched on to protect the compressor.
Odours from the compartments	The interior may need to be cleaned
	Some food, containers or wrapping cause odours.
Noise from the appliance	The sounds below are quite normal: <ul style="list-style-type: none"> <li>•Compressor running noises.</li> <li>•Air movement noise from the small fan motor in the freezer compartment or other compartments.</li> <li>•Gurgling sound similar to water boiling.</li> <li>•Popping noise during automatic defrosting.</li> <li>•Clicking noise before the compressor starts.</li> </ul>
	Other unusual noises are due to the reasons below and may need you to check and take action: <ul style="list-style-type: none"> <li>•The cabinet is not level.</li> <li>•The back of appliance touches the wall.</li> <li>•Bottles or containers fallen or rolling.</li> </ul>
A layer of frost occurs in the compartment	Check that the air outlets are not blocked by food and ensure food is placed within the appliance to allow sufficient ventilation. Ensure that door is fully closed. To remove the frost, please refer to the "Cleaning and care" chapter.
Temperature inside is too warm	You may have left the doors open too long or too frequently; or the doors are kept open by some obstacle; or the appliance is located with insufficient clearance at the sides, back and top

---

Temperature inside is too cold	Increase the temperature by following the “Display controls” chapter.
Doors can't be closed easily	Check whether the top of the refrigerator is tilted back by 10-15mm to allow the doors to self close, or if something inside is preventing the doors from closing.
The light is not working	<ul style="list-style-type: none"><li>•The LED light may be damaged. Refer to replace LED lights in “Cleaning and Care” chapter of manual.</li><li>•The control system has disabled the lights due to the door being kept open too long. Close and reopen the door to reactivate the lights.</li></ul>

## 5.2 Faulty start

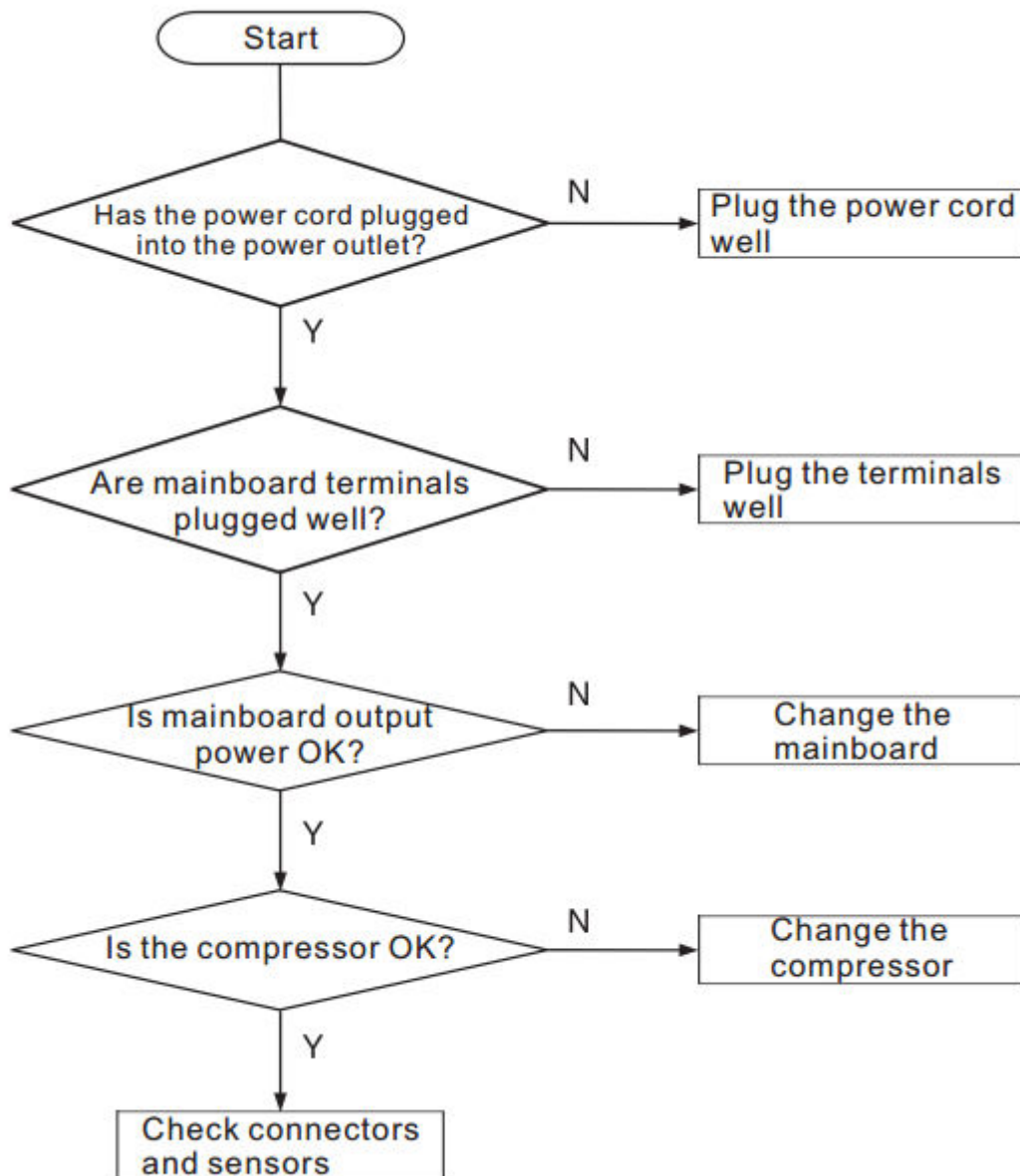

## 5.3 Refrigeration failure

### 5.3.1 Fridge compartment

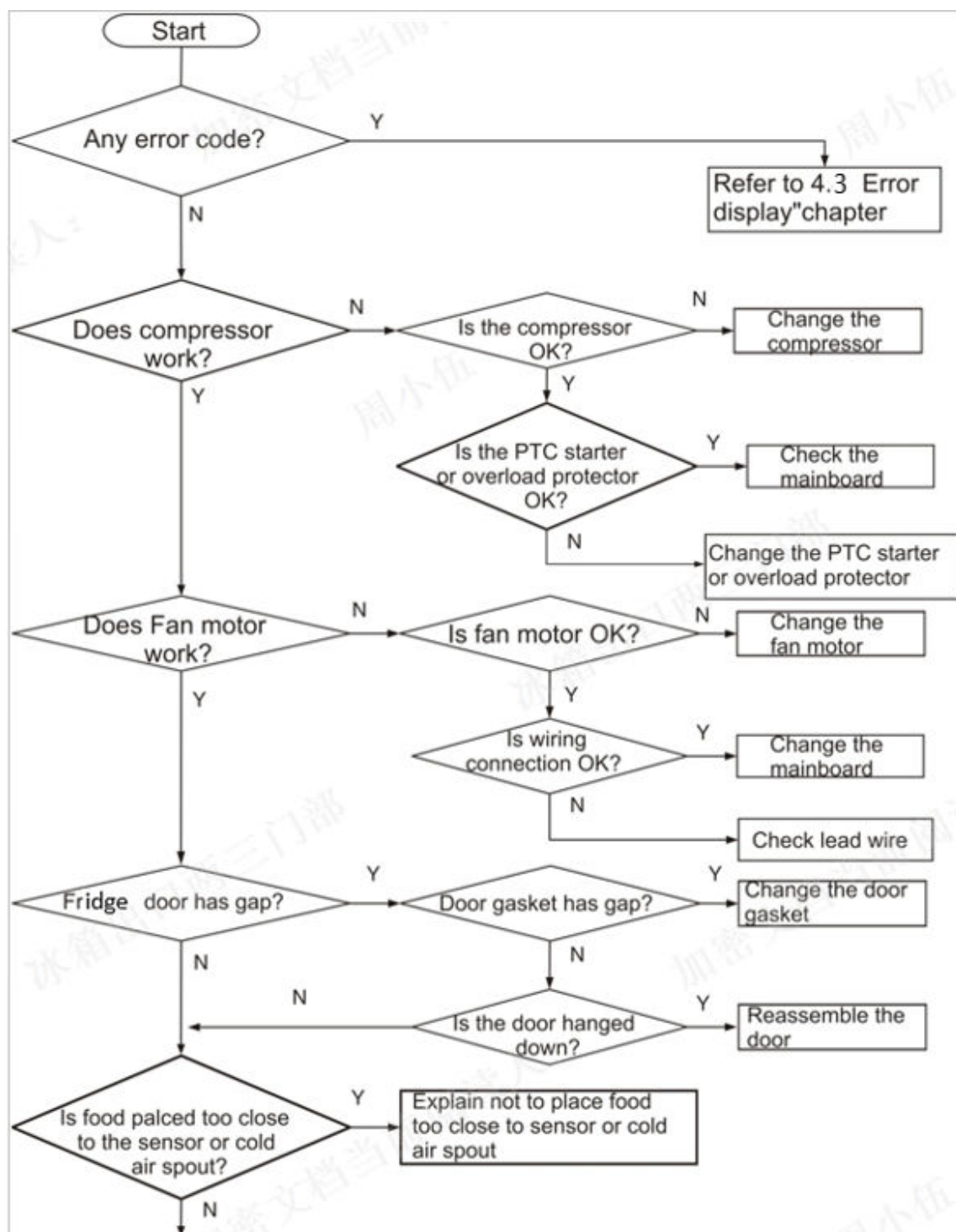

### 5.3.1 Fridge compartment

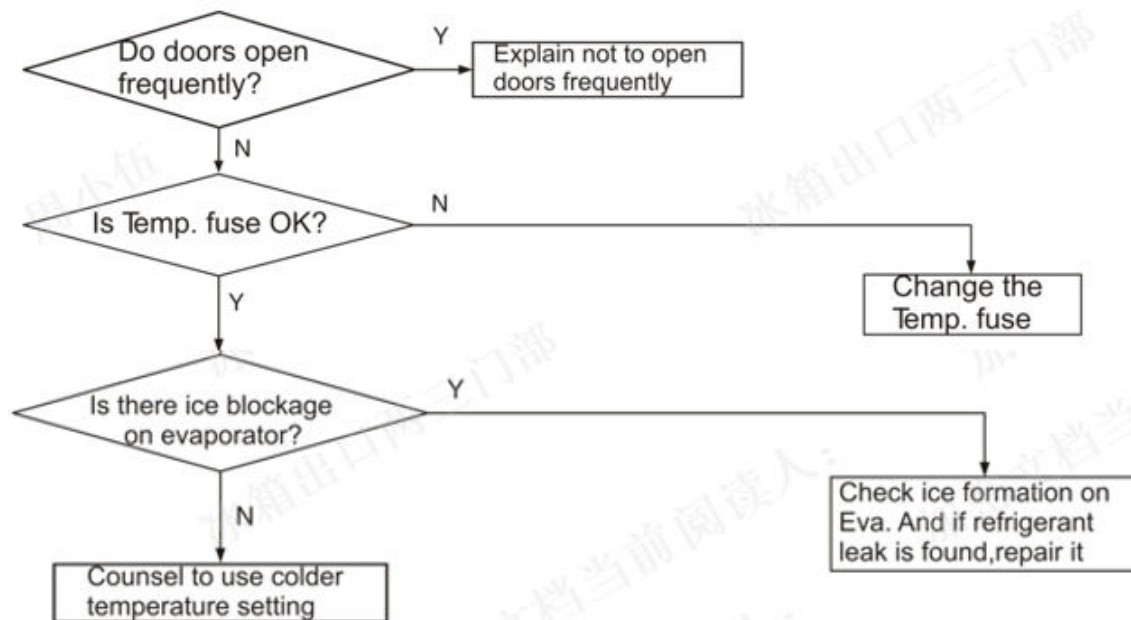

### 5.3.2 Refrigerator compartment

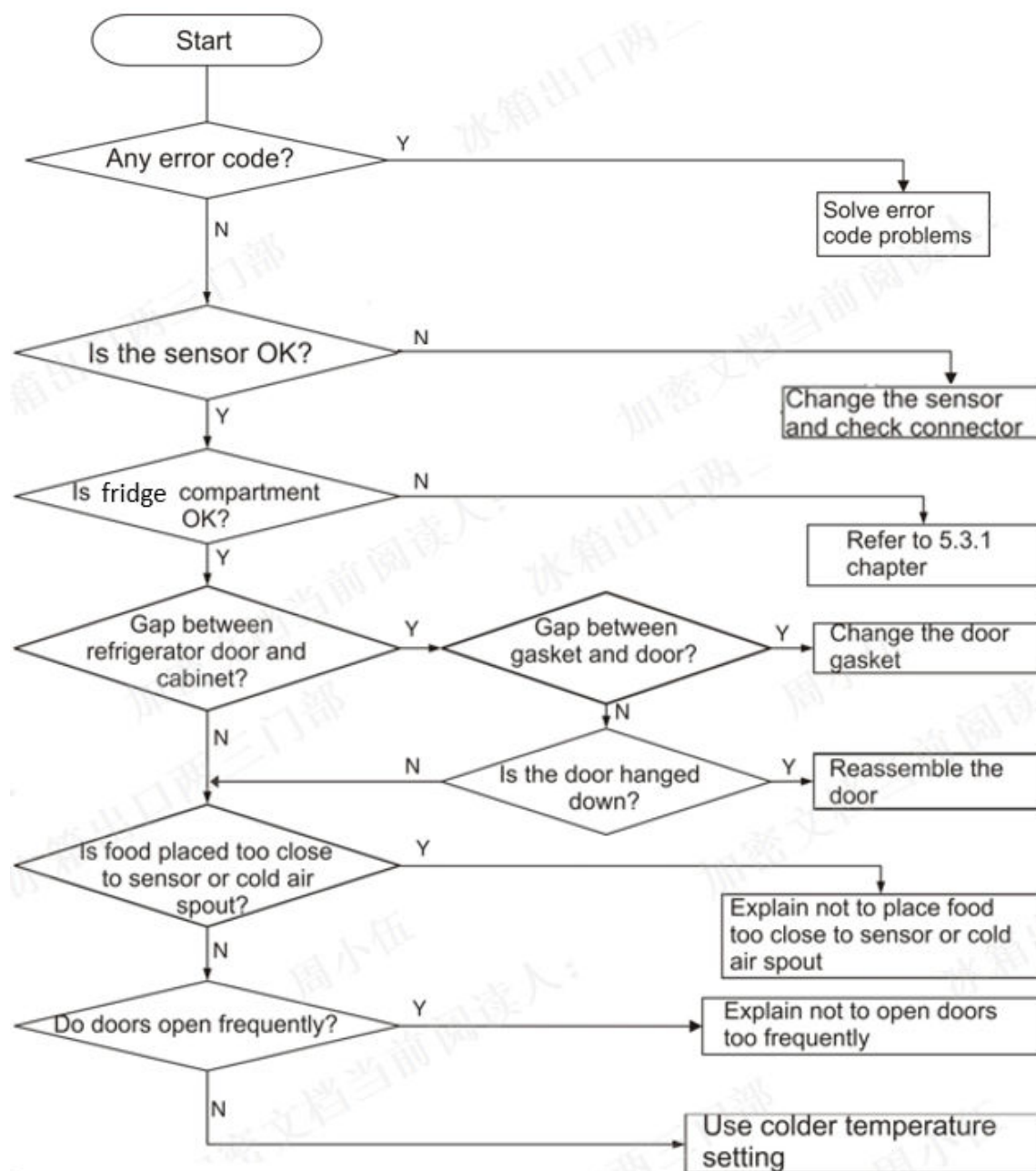

## 5.4 Thick frost in refrigerator compartment

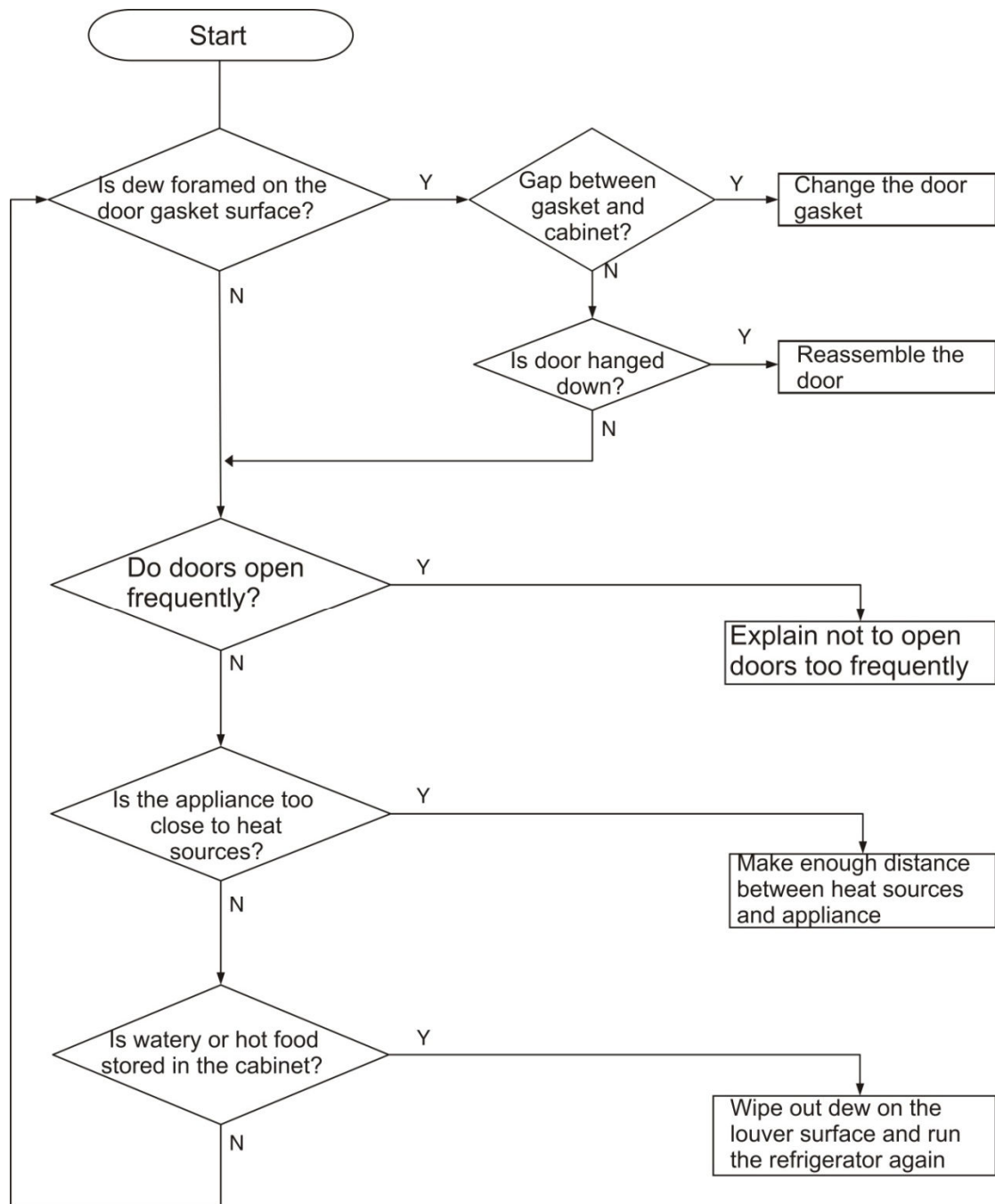

## 5.5 Dew in refrigerator compartment

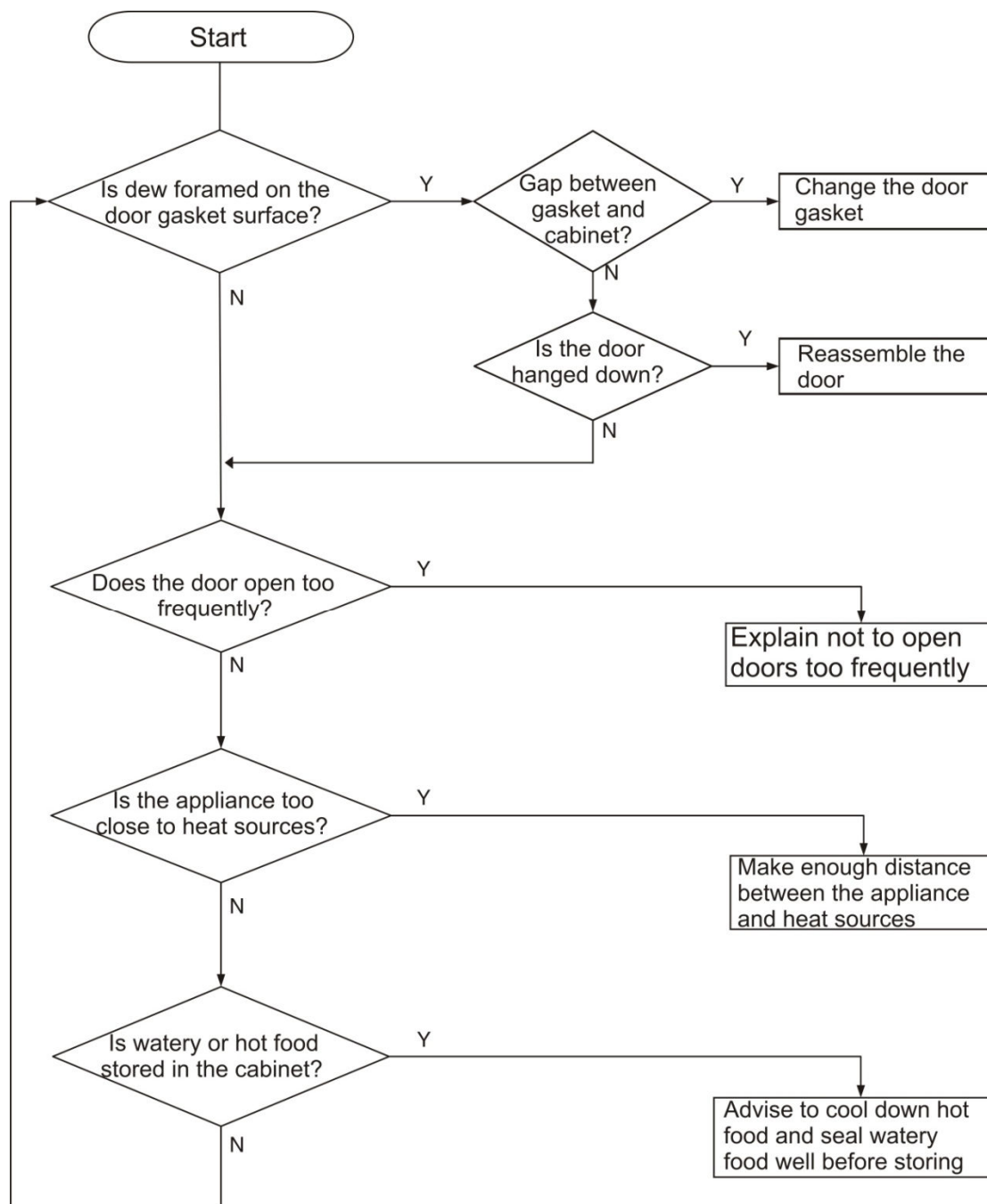



## 5.6 Breaking of light

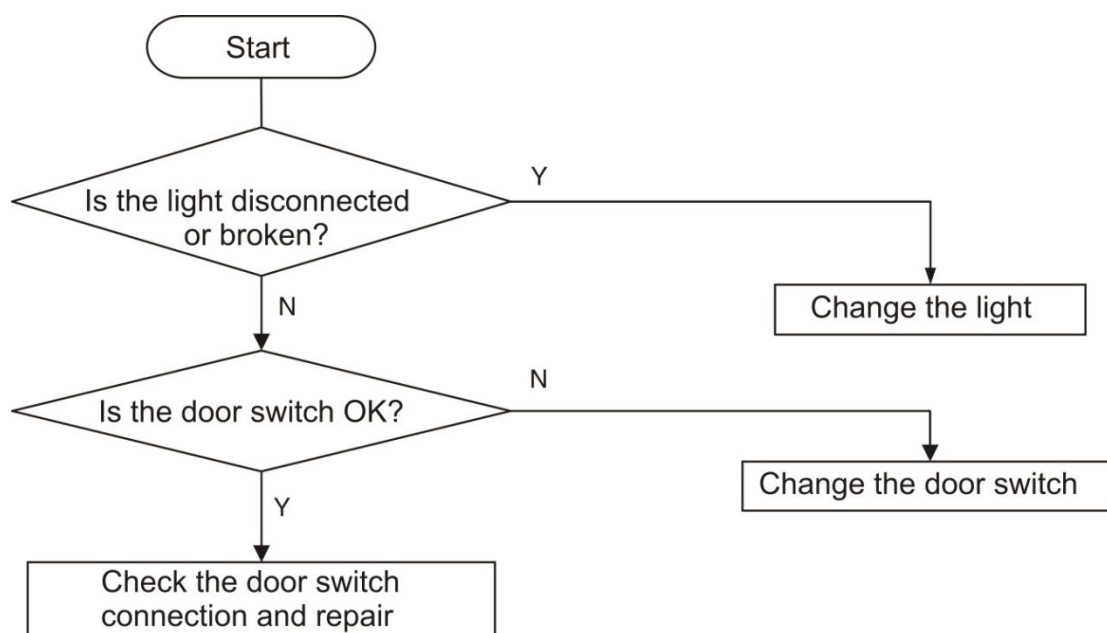

## 5.7 Noise

### 5.7.1 Compressor noise

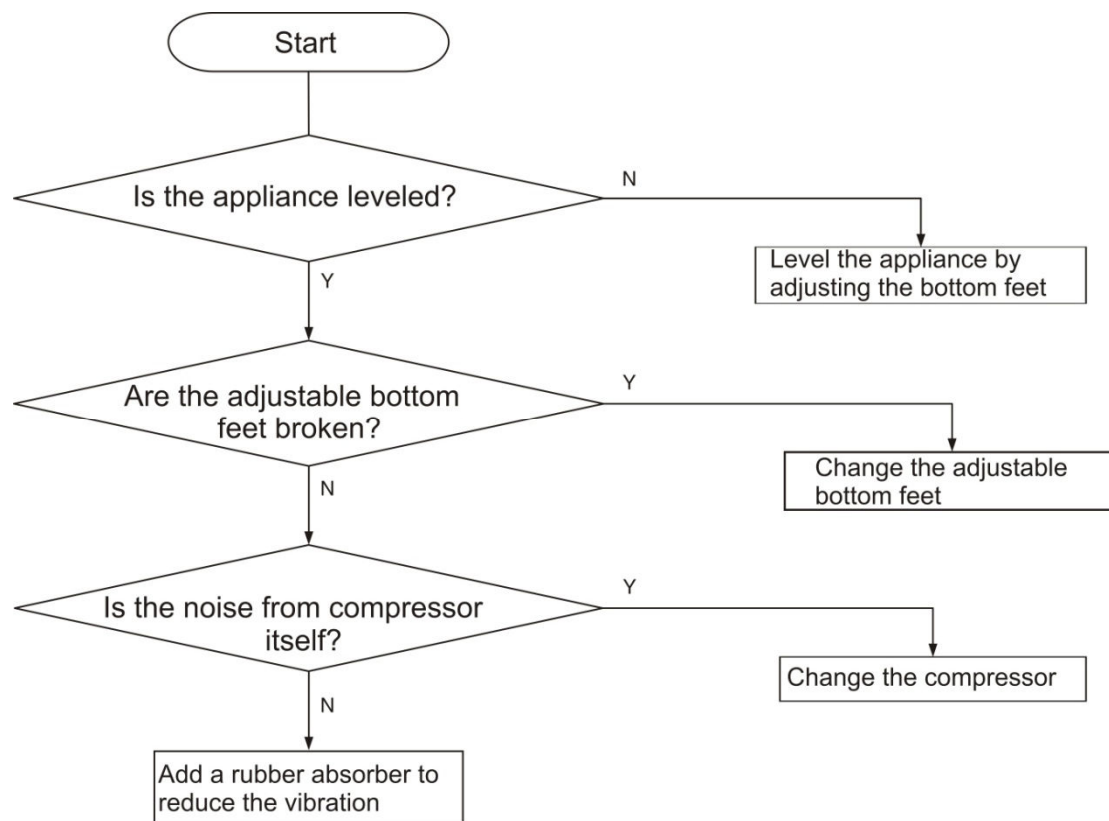

## 5.7.2 Refrigerator flowing noise

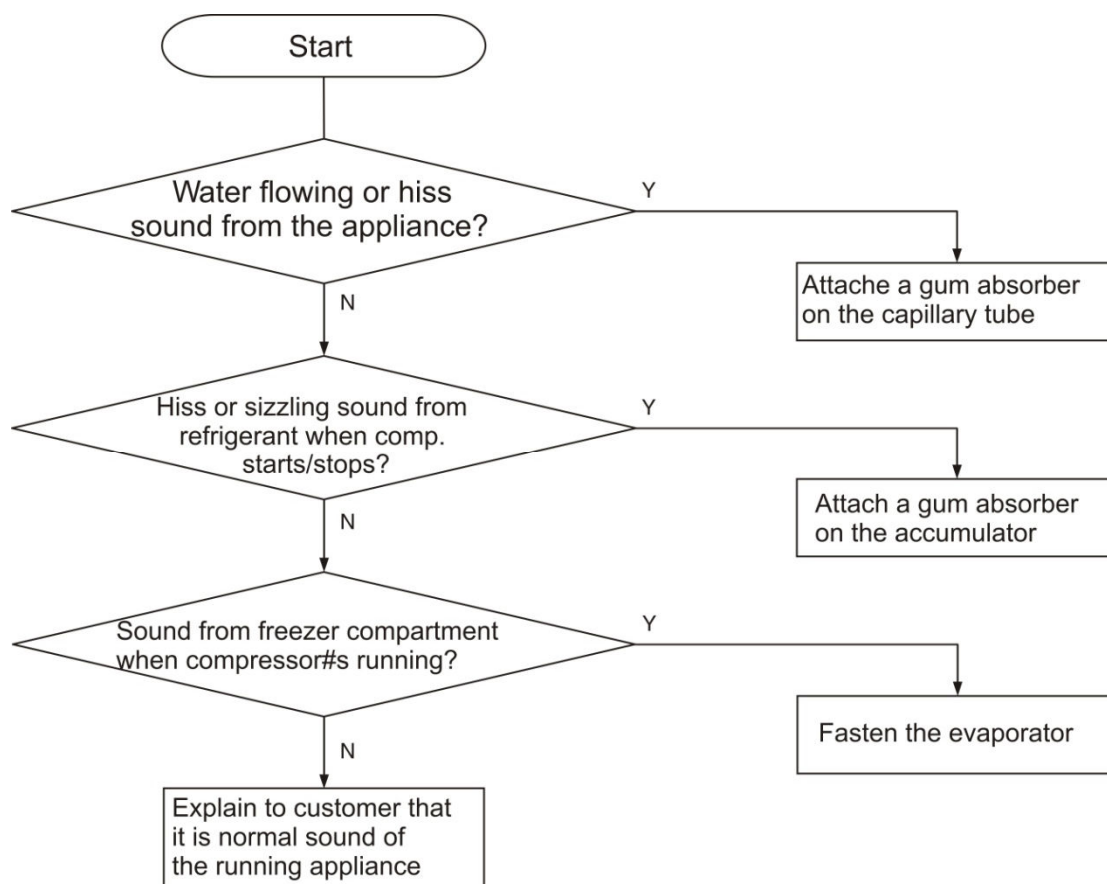

### 5.7.3 Fan motor noise

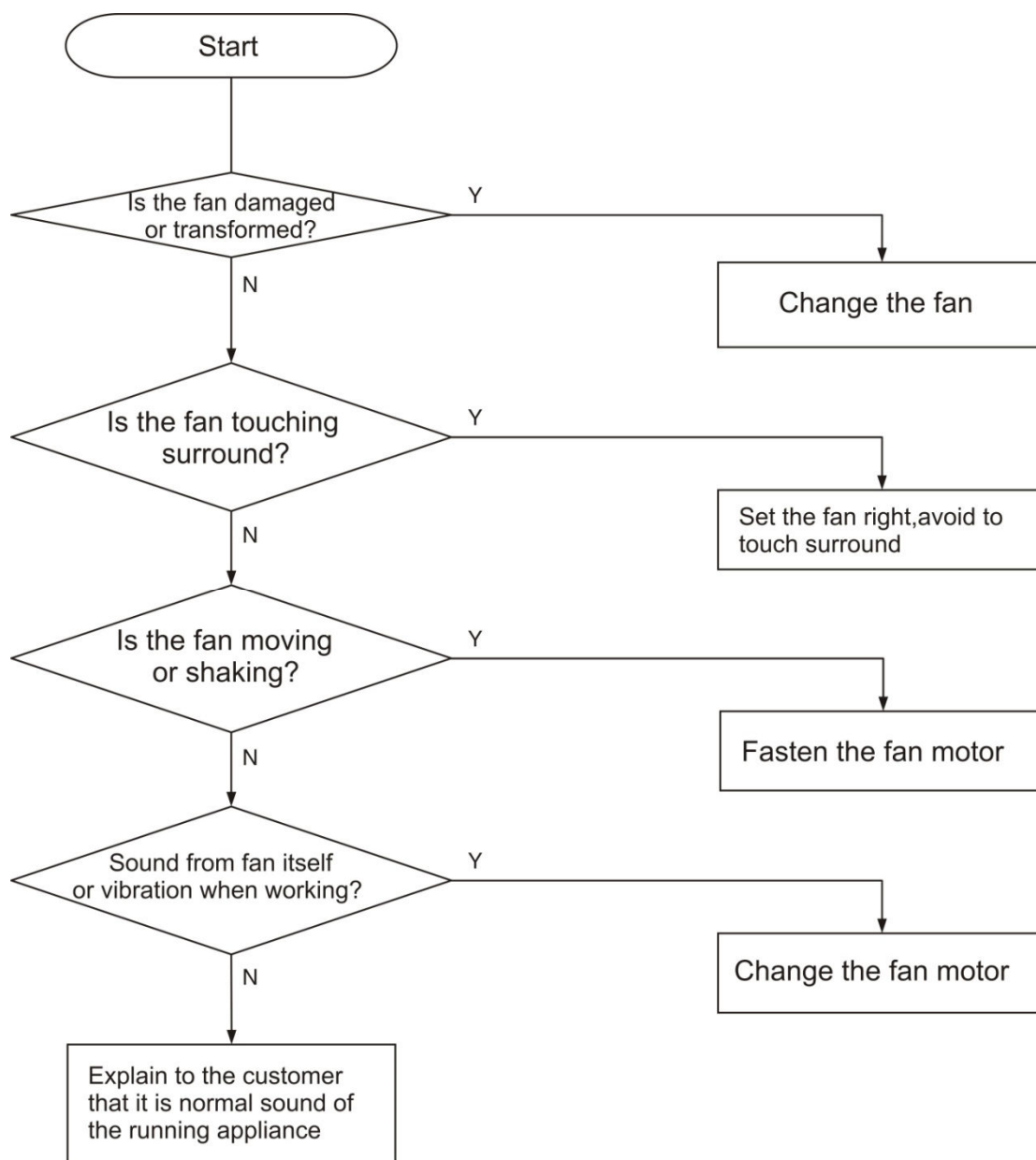

### 5.7.4 Pipe noise

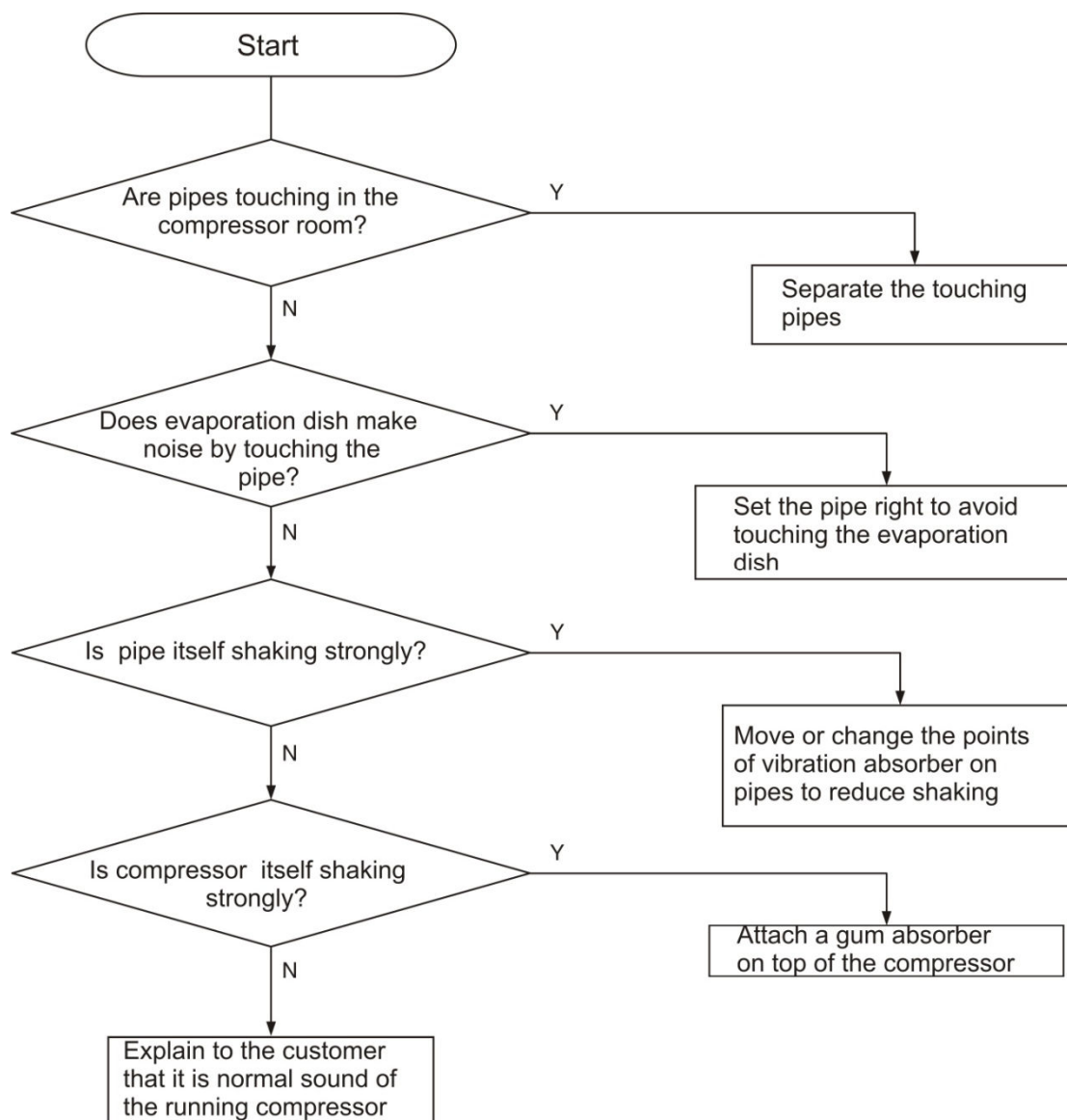

## 6. Circuit and checking

### 6.1 Circuit diagram

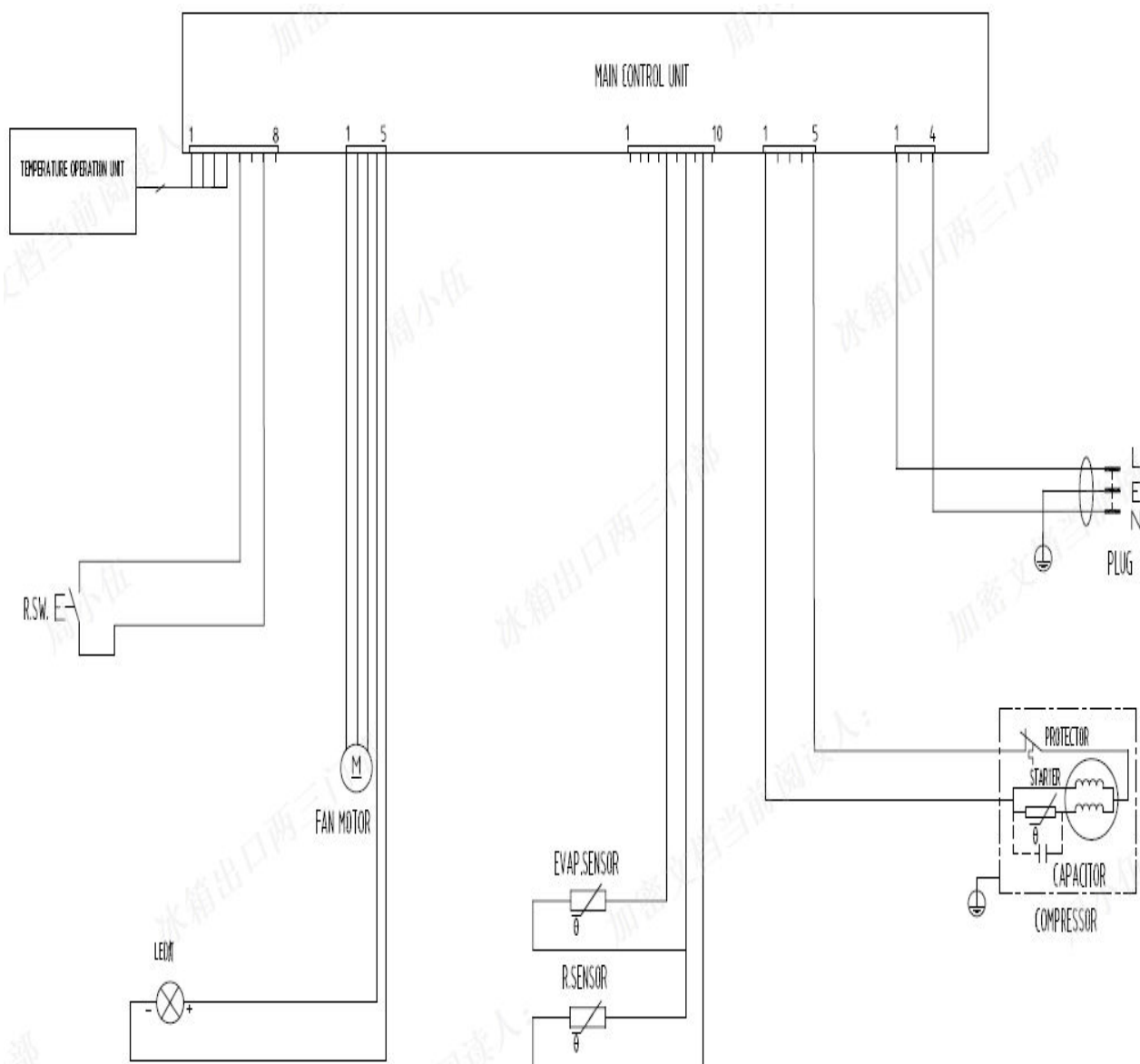

### 6.2 Main control board

#### 6.2.1 Checking method

If the problem is probably caused by main control board, change it directly to confirm.

#### 6.2.2 Removing the main control board

1. Unplug the appliance
2. Remove the screws by screwdriver and remove the electric box cover, as picture 1 and picture 2.
3. Unplug the terminals on the main control board as picture 3.
4. Press the two snap-fits and remove the main control board as picture 4.

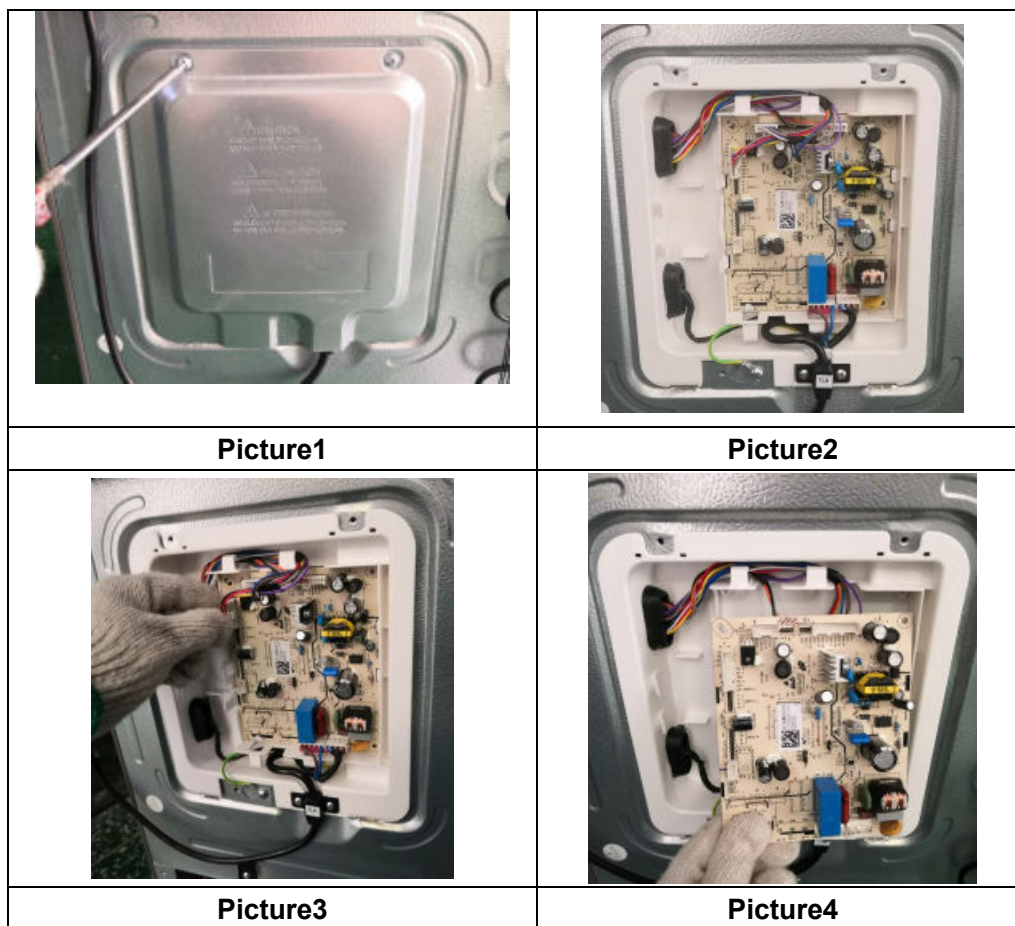

## 6.3 Compressor

### 6.3.1 Basic parameters

Input voltage:220~240V

Input frequency:50Hz

### 6.3.2 Checking method

- 1.Compressor will start 10 seconds after power-on, if it starts unsuccessfully, remove the electric box cover and check.
- 2.Check the connecting wiring between compressor and main control board and repair if it is broken.
- 3、 Use a multimeter to measure voltage between pin No.1 and No.5 on CN7 connector of main control board; If the voltage equal to electric supply power, it means the main control board is OK, to change the Compressor , otherwise change the main control board.

#### 6.3.2.1 Compressor checking

Use a multi-meter to test the resistance between C & S, M&S and M&C :

Normal range of C&S : About  $6.8 \pm 7\% \Omega$

Normal range of M&S : About  $6.8 \pm 7\% \Omega$

Normal range of M&C : About  $6.8 \pm 7\% \Omega$

If the test result is not in this range then it means the inner coil has some problem and the compressor cannot work properly.



---

***Hisense Refrigerator***



### 6.3.3 Removing the PTC starter and overload protector

#### 6.Circuit and checking

1.Unplug the appliance

2.Remove the screws of protector box by screwdriver,as picture 1.

3.Pry up the protector box from top by screwdriver,as picture 2.

4.Unplug the overload protector,as picture 3.

5.Unplug the PTC starter,as picture 4.

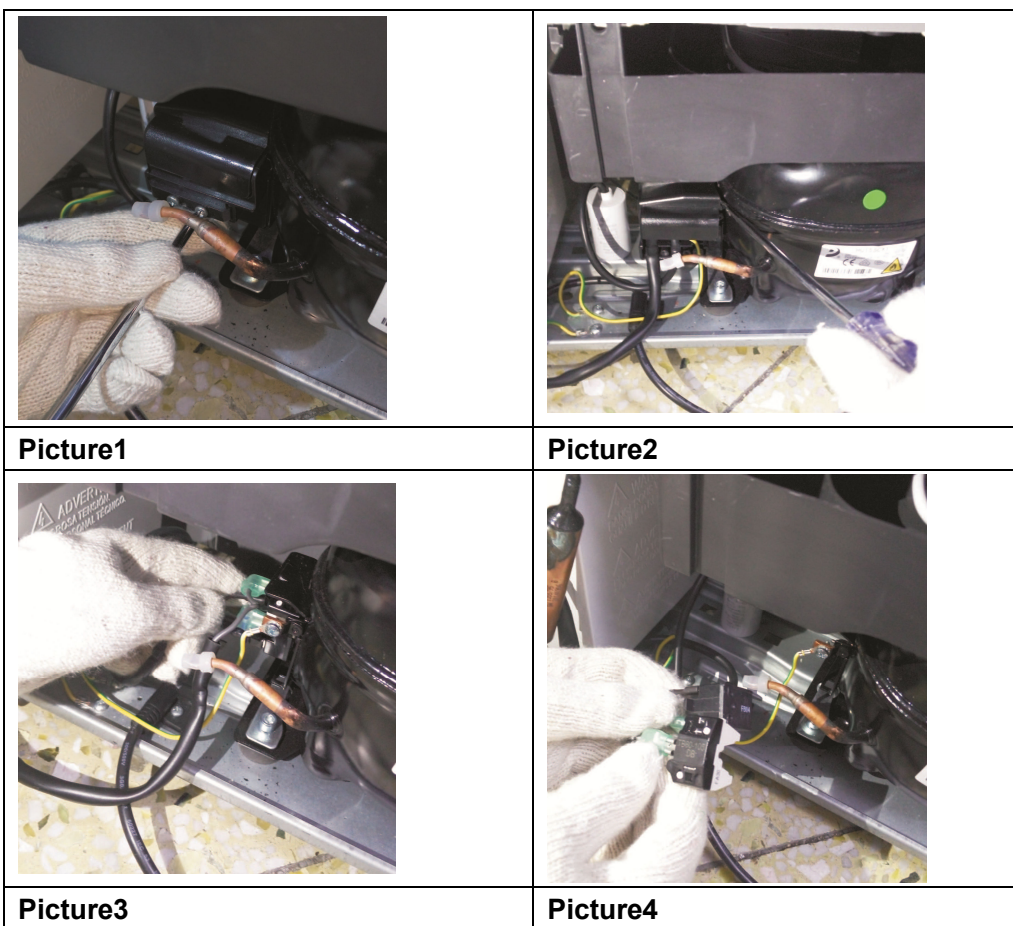

## 6.4 Fan motor

### 6.4.1 Basic parameters

Rated voltage:DC12V

Rated input power: <2.51W







### 6.4.2 Checking method

1. Check the connecting wiring of fan motor is well or not, repair if it is broken. The fridge fan motor corresponding pin No.1~3 on CN9 connector of mainboard.
2. Pin No.1 connect 12V power and pin No.2 connect GND. If the fridge (refrigerator) fan motor works normally, change the mainboard; If not, change the fan motor.

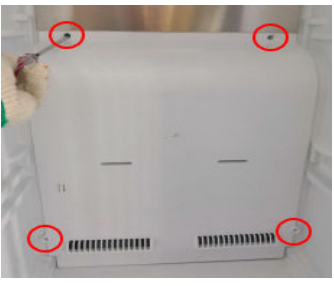
### 6.4.3 Removing the fan motor

#### 6.4.3.1 Removing the fridge fan motor

1. Unplug the appliance.
2. Remove the fridge door and remove the drawers and ice tray as picture 1.
3. Remove the screws by screwdriver as picture 2.
4. Unplug the terminal as picture 3 and remove the wind channel component as picture 4.
5. Tear the tape around the wind channel component, open the buckles then separate two part of the wind channel component as picture 5 and 6.
6. Remove the screws by screwdriver as picture 7 and pull out the fan motor as picture 8.

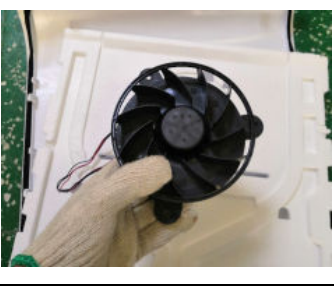
		
<b>Picture1</b>	<b>Picture2</b>	<b>Picture3</b>
		
<b>Picture4</b>	<b>Picture5</b>	<b>Picture6</b>
		
<b>Picture7</b>	<b>Picture8</b>	

## 6.5 Light

### 6.5.1 Basic parameters

Rated voltage: DC12V

Rated power: 2W

### 6.5.2 Checking method

1. Check the connecting wiring between light and main control board is well or not, repair if it is broken. Refrigerator light corresponding pin No.4 and No.5 on CN9 connector of mainboard.

2. Check output voltage corresponding light of the main control board, if it is 12V, it means the mainboard is OK, change the light; If not, it means the main control board is broken, change it.

### 6.5.3 Removing the light

1. Unplug the appliance
2. Pry up the light cover with a pin or other spikers as picture 1.
3. Catch the light cover with one hand and pull down it as picture 2.
4. Take the LED light out and unplug the terminal as picture 3 and 4

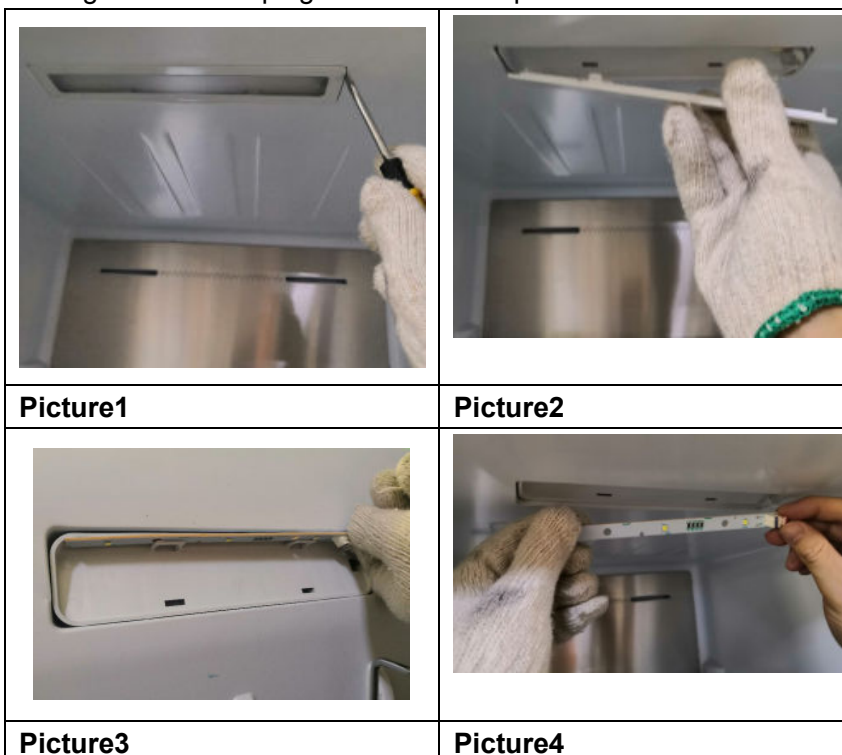

## 6.6 Display panel

### 6.6.1 Basic parameters

Input voltage:5V

### 6.6.2 Checking method

1. Display panel will lighten as soon as power-on, if it light unsuccessful, remove the display panel box cover and check.
2. Check the connecting wiring between display panel and main control board and repair if it is broken.
3. Use a multimeter to measure voltage between pin No.3 and No.4 on CN4 connector of main control board, If the voltage equal to 5V, it means the display panel is broken, change it; If not, change the main control board.

### 6.6.3 Removing the display panel

1. Unplug the appliance.
2. After unplugging the terminal of the display panel, remove the screws of the display panel by screwdriver as picture 1 and 2.
3. Take the display panel out as picture 3 and 4.

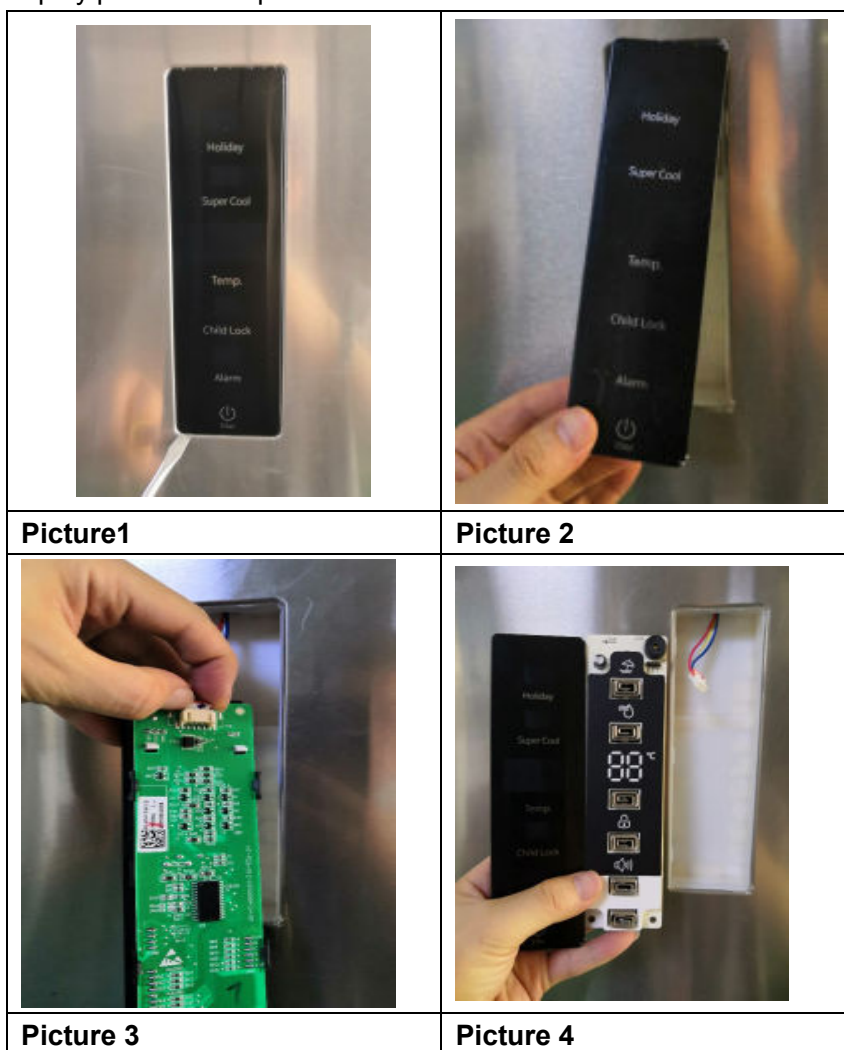

## 6.7 Sensor

### Measuring the sensor resistance

Use a multimeter with the ohm switch to measure the resistor of sensor.

You'd better measure the following temperature resistance is more accurate, and more likely to get the temperature. Normally at surrounding  $-18^{\circ}\text{C}$ ,  $5^{\circ}\text{C}$ ,  $25^{\circ}\text{C}$ , the corresponding resistance is about 17kohm, 5kohm, 2kohm. If the measured value is not within the normal scope, the sensor is bad and needs to repair or change.



## 6.8 Door switch

1. Unplug the appliance.
2. Using a screwdriver to pry the upper cover plate and take out switch, as picture 1.
3. Take out the switch, as picture 2.



Picture1



Picture 2

## 7. Cooling system repairing

### 7.1 Refrigeration system

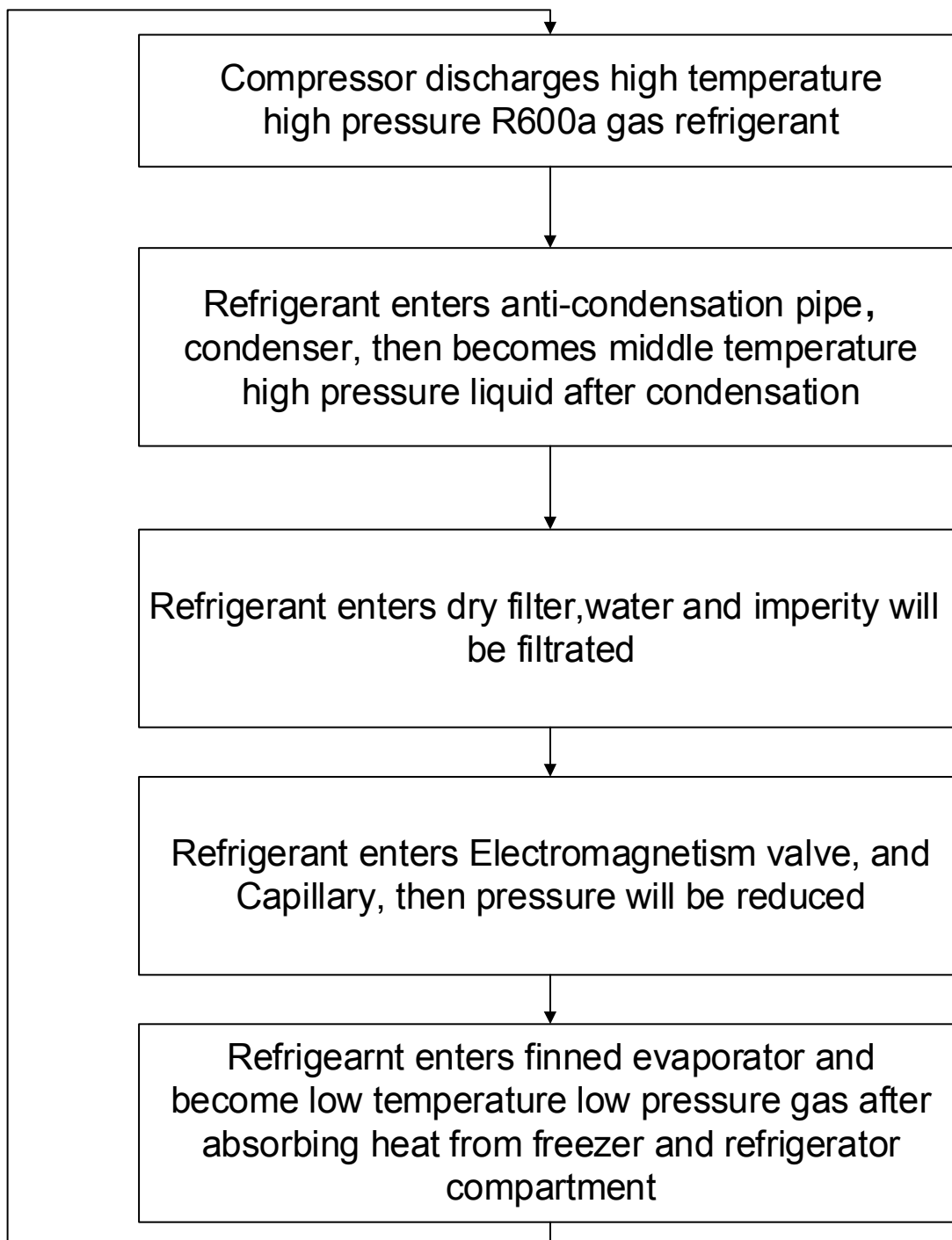

## 7.2 Summary of repair

Process	Contents	Tools
Remove refrigerant Residuals	* Cut charging pipe ends (Comp. & Dryer) and discharge refrigerant from drier and compressor.	* Nipper, side cutters
Parts replacement and welding	* Confirm refrigerant (R-134a or R-600a) and oil for compressor and drier. * Confirm N2 sealing and packing conditions before use. Use good one for welding and assembly. * Repair in a clean and dry place.	* Pipe Cutter, Gas welder, N2 gas
Vacuum	* Evacuate for more than forty minutes after connecting manifold gauge hose and vacuum pump to high (drier) and low (compressor) pressure sides.	* Vacuum pump , Manifold gauge.
Refrigerant charging and charging inlet welding	* Weigh and control the bombe in a vacuum conditions with electronic scales and charge through compressor inlet (Process tube). * Charge while refrigerator operates). * Weld carefully after inlet pinching.	* Bombe (mass cylinder), refrigerant manifold gauge, electronic scales, punching off flier, gas welding machine
Check refrigerant leak and cooling capacity	* Check leak at weld joints. Note :Do not use soapy water for check. * Check cooling capacity → Check condenser manually to see if warm. → Check hot pipe manually to see if warm. → Check frost formation on the whole surface of the evaporator.	* Electronic Leak Detector, Driver.
Compressor compartment and tools arrangement	* Remove flux from the silver weld joints with soft brusher wet rag. (Flux may be the cause of corrosion and leaks.) *Clean tools and store them in a clean tool box or in their place.	* Copper brush, Rag, Tool box
Transportation and installation	* Installation should be conducted in accordance with the standard installation procedure. (Leave space of more than 5 cm from the wall for compressor compartment cooling fan mounted model.)	

## 7.3 Regulation of repair

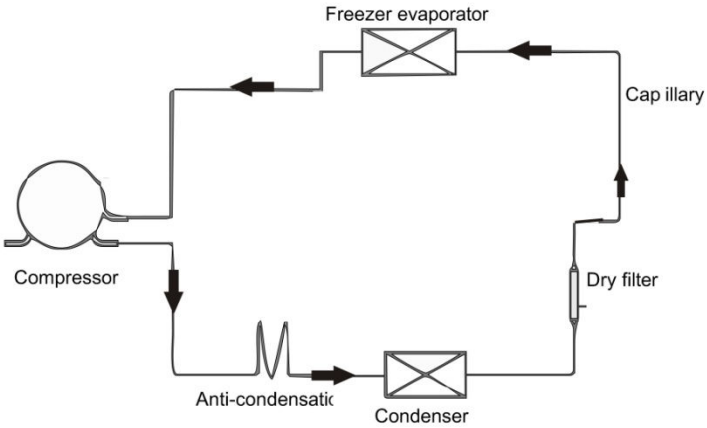
Items	Precautions
Use of tools.	1) Use special parts and tools for R-134a or R-600a
Removal of retained refrigerant.	<p>1) Remove retained refrigerant more than 5 minutes after turning off a refrigerator. (If not, oil will leak inside.)</p> <p>2) Remove retained refrigerant by cutting first high pressure side (drier part) with a nipper and then cut low pressure side. (If the order is not observed, oil leak will happen.)</p> 
Replacement of drier.	1) Be sure to replace drier when repairing pipes and injecting refrigerant.
Nitrogen blowing welding.	1) Weld under nitrogen atmosphere in order to prevent oxidation inside a pipe. (Nitrogen pressure : 0.1~0.2 kg/cm2.)
Others.	<p>1) Nitrogen only should be used when cleaning inside of cycle pipes inside and sealing.</p> <p>2) Check leakage with an electronic leakage tester.</p> <p>3) Be sure to use a pipe cutter when cutting pipes.</p> <p>4) Be careful not the water let intrude into the inside of the cycle.</p>

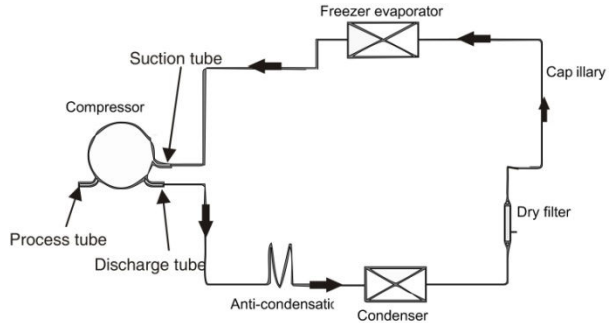
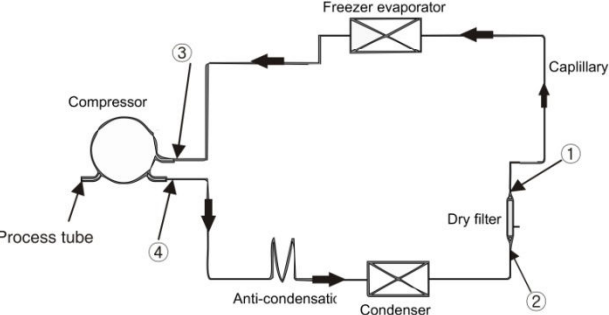

## 7.4 Practical work of repair

Items	Precautions
<p>1. Removal of residual refrigerant.</p>	<p>1) Remove residual refrigerant more than 5 minutes later after turning off the refrigerator. ( If not, compressor oil may leak inside.)            2) Remove retained refrigerant slowly by cutting first high pressure side (drier part) with a nipper and then cut low pressure side.</p> 
<p>2. Nitrogen blowing welding.</p>	 <p>* <b>When replacing a drier:</b>        Weld 1 and 2 parts by blowing nitrogen (0.1~0.2kg/cm<sup>2</sup>) to high pressure side after assembling a drier.</p> <p>* <b>When replacing a compressor:</b>        Weld 3 and 4 parts by blowing nitrogen to the low pressure side.        Note) For other parts, nitrogen blowing is not necessary because it does not produce oxidized scales inside pipe because of its short welding time.</p> <p>- <b>KEYPOINTING</b>        Welding without nitrogen blowing produces oxidized scales inside a pipe, Which affect on performance and reliability of a product.</p>

## 7.4 Practical work of repair

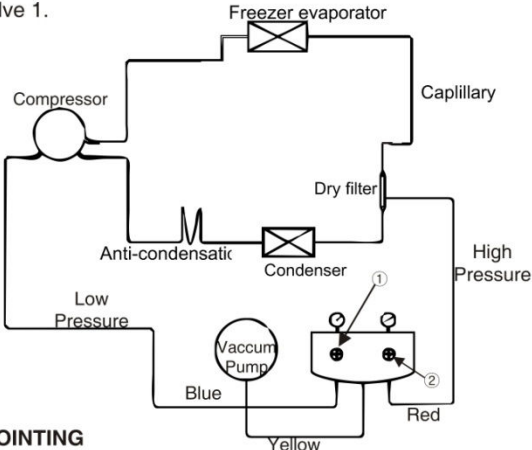
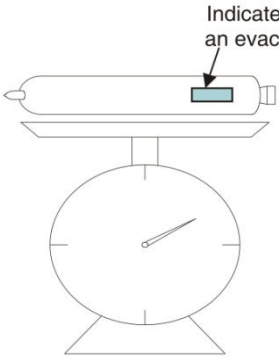
Items	Precautions
3.Vacuum degassing.	<p><b>* Pipe Connection</b> Connect a red hose to the high pressure side and a blue hose to the low pressure side.</p> <p><b>* Vacuum Sequence</b> Open 1,2 valves and evacuate for 40 minutes. Close valve 1.</p>  <p><b>※ KEYPOINTING</b></p> <ol style="list-style-type: none"> <li>1) If power is applied during vacuum degassing, vacuum degassing shall be more effective.</li> <li>2) Operate compressor while charging refrigerant. (It is easier and more certain to do like this.)</li> </ol>
4.Refrigerant charging.	<p><b>* Charging sequence</b></p> <ol style="list-style-type: none"> <li>1) Check the amount of refrigerant supplied to each model after completing vacuum degassing.</li> <li>2) Evacuate bombe with a vacuum pump.</li> <li>3) Measure the amount of refrigerant charged. <ul style="list-style-type: none"> <li>- Measure the weight of an evacuated bombe with an electronic scale.</li> <li>- Charge refrigerant into a bombe and measure the weight. Calculate the weight of refrigerant charged into the bombe by subtracting the weight of an evacuated bombe.</li> </ul> </li> </ol>  <p><b>- KEYPOINTING</b></p> <ol style="list-style-type: none"> <li>1) Be sure to charge the refrigerant at around 25C.</li> <li>2) Be sure to keep -5g in the winter and +5g in summer.</li> </ol> <p><b>Calculation of amount of refrigerant charged</b></p> <p>the amount of refrigerant charged = a weight after charging - a weight before charging (a weight of an evacuated cylinder)</p>

## 7.5 Brazing reference drawing

