

# Refrigerator

## Service manual

NO FROST

Model: CKS4185X, CKS4185V



**NOTE:** product specifications are subject to change.

\_\_\_\_\_

\_\_\_\_\_

\_\_\_\_\_

# Contents

Warnings and precautions for safety.....	2
Parts Description.....	3
Circuit diagram .....	4
Compulsory defrost .....	4
Cooling diagram .....	5
Display controls.....	6
Compulsory defrost .....	7
Checking the Compressor.....	7
Checking the heater .....	9
Checking the defrost fuse .....	9
Measuring the sensor resistance .....	10
The guide for Disassembly Common parts of Refrigerator.....	11
◆The instruction of replacing the main board and display board.....	11
◆The instruction of of replacing fan motor .....	12
◆The instruction of replacing temperature sensor.....	13
◆The instruction of replacing evaporator temperature sensor and temperature fuse and heater .....	13
◆The instruction of replacing PTC Starting relay and Overload protector. ....	14
◆The instruction of replacing Door switch. ....	14
◆The instruction of replacing Display board. ....	15
◆The instruction of of replacing LED Light. ....	15
Installing your new appliance.....	16
Troubleshooting.....	20
◆ The solution for digital display code problem: .....	20
◆ The common problem judgement method .....	20
◆ The solution for the common problem.....	21
■ NOTE: .....	24

## **Warnings and precautions for safety**

Please observe the following safety precautions in order to use safely and correctly the refrigerator and to prevent accident and danger during repair.

1. Be care of an electric shock. Disconnect power cord from wall outlet and wait for more than three minutes before replacing PCB parts.

Shut off the power whenever replacing and repairing electric components.

2. When connecting power cord, please wait for more than five minutes after power cord was disconnected from the wall outlet.

3. Please check if the power plug is pressed down by the refrigerator against the wall.

If the power plug was damaged, it may cause fire or electric shock.

4. If the wall outlet is over loaded, it may cause fire.

Please use its own individual electrical outlet for the refrigerator.

5. Please make sure the outlet is properly earthed, particularly in wet or damp area.

6. Use standard electrical components when replacing them.

7. Make sure the hook is correctly engaged.

Remove dust and foreign materials from the housing and connecting parts.

8. Do not fray, damage, machine, heavily bend, pull out or twist the power cord.

9. Please check the evidence of moisture intrusion in the electrical components.

Replace the parts or mask it with insulation tapes if moisture intrusion was confirmed.

10. Do not touch the icemaker with hands or tools to confirm the operation of geared motor.

11. Do not let the customers repair, disassemble and reconstruct the refrigerator for themselves.

It may cause accident, electric shock, or fire.

12. Do not store flammable materials such as ether, benzene, alcohol, chemicals, gas, or medicine in the refrigerator.

13. Do not put flower vase, cup, cosmetics, chemicals, etc., or container with full of water on the top of the refrigerator.

14. Do not put glass bottles with full of water into the freezer.

The contents shall freeze and break the glass bottles.

15. When you scrap the refrigerator, please disconnect the door gasket first and scrap it

## Parts Description

1. Cabinet
2. LED light
3. Glass shelf
4. Small glass shelf
5. 0°C cool plus
6. Crisper cover
7. Humidity control sliding block
8. Moisture fresh crisper
9. Adjustable bottom feet
10. Covered dairy rack
11. Egg tray(inside)
12. Middle rack
13. Bottle holder(inside)
14. Easy handle
15. Bottle rack
16. Fridge door
17. Fridge door seal

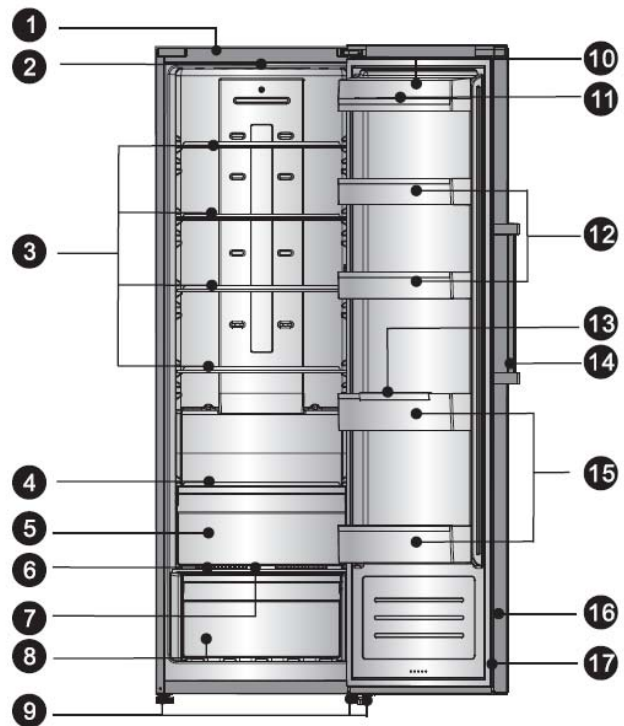

## Circuit diagram

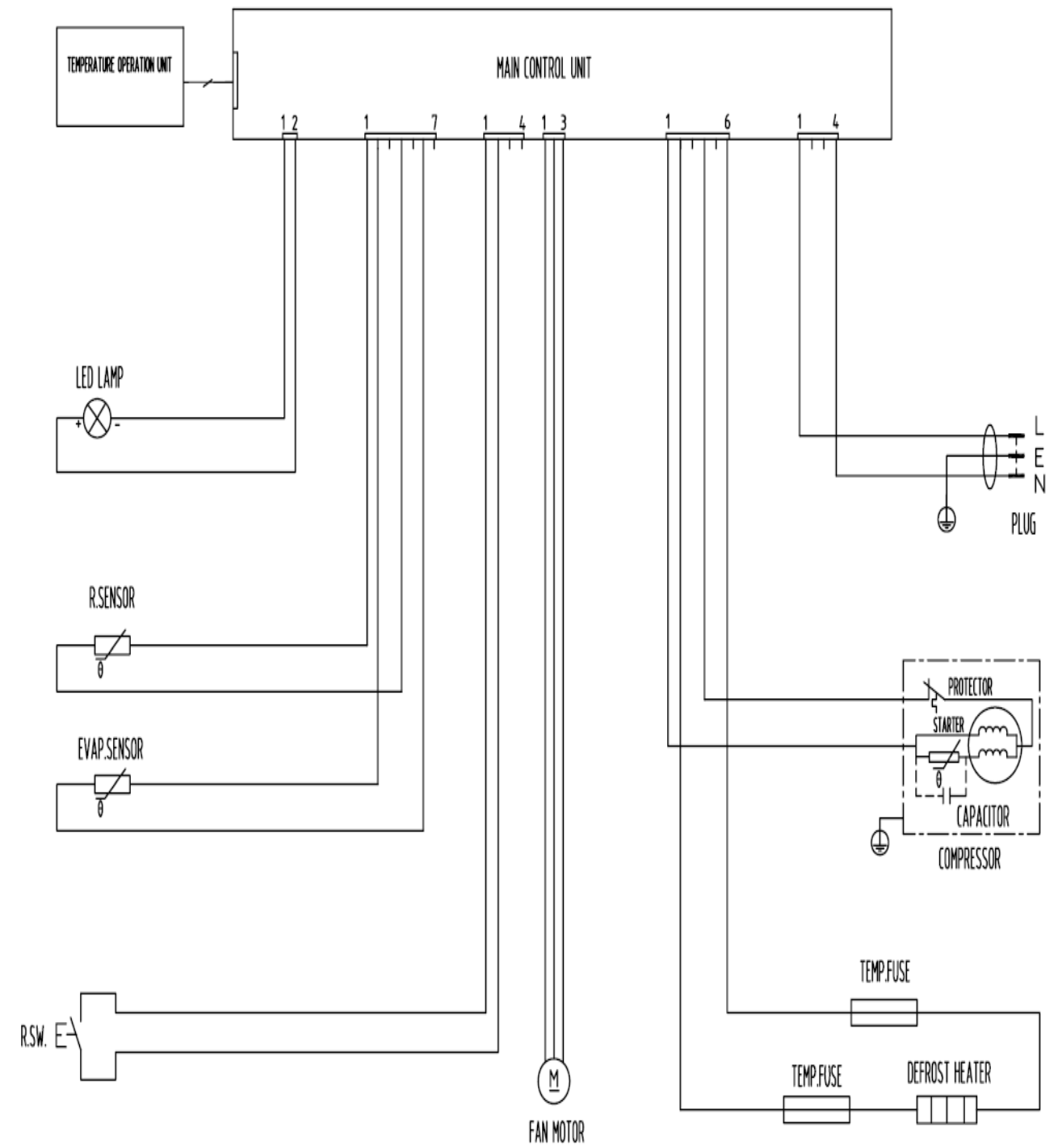

## Compulsory defrost

Connecting power within 1 minute, refrigerator or freezer door open situation, press Fridge and super cool 3 seconds, enter the compulsory defrosting process:

—After entering the compulsory defrosting, we can run the defrosting same as the normal automatic defrosting process.

—Under compulsory defrosting process, displaying b area displays from 99 to 00.

After exiting the entire compulsory defrosting process, it reverts to normal operation and display.

# Cooling diagram

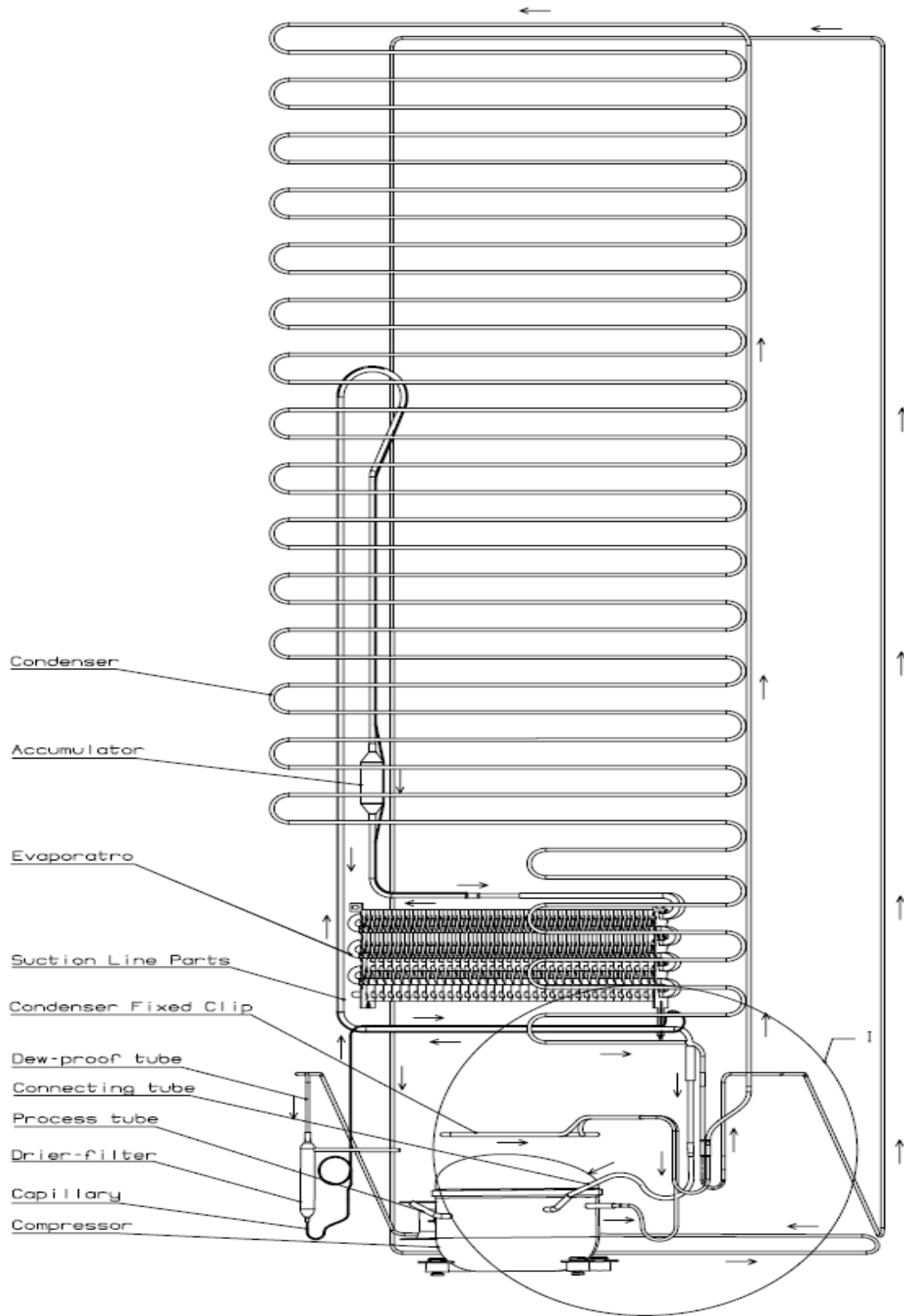

## Display controls

Use your appliance according to the following control regulations, your appliance has the corresponding functions and modes as the control panels showed in the pictures below. When the appliance is powered on for the first time, the backlighting of the icons on display panel starts working. If no buttons have been pressed and the doors are closed, the backlighting will turn off.



### Controlling the temperature

We recommend that when you start your refrigerator for the first time, the temperature for the refrigerator is set to 4°C. If you want to change the temperature, follow the instructions below.

**Caution!** When you set a temperature, you set an average temperature for the whole refrigerator cabinet. Temperatures inside each compartment may vary from the temperature values displayed on the panel, depending on how much food you store and where you place them. Ambient temperature may also affect the actual temperature inside the appliance.

### 1. Fridge

Press "Fridge" to set fridge temperature between 2°C and 8°C as needed, and control panel will display corresponding values according to the following sequence.

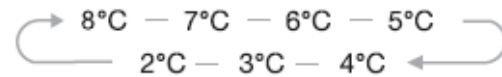

### 2. Super Cool



Super Cool can refrigerate your food much faster, keeping food fresh for a

longer period.

● Press "Super Cool" button to activate this function. The light will be illuminated.

Super cool automatically switches off after 6 hours and the refrigerator temperature setting displays 2°C.

● When super cool function is on you can switch it off by pressing "Super Cool" or "Refrigerator" button and the refrigerator temperature setting will revert back to the previous setting.

### 3. Holiday



If you are going to be away for a long period of time, you can activate this function by

pressing "Holiday" button for 3 seconds until the light comes on.

● When the holiday function is activated, the temperature of the refrigerator is automatically switched to "-" to minimize the energy consumption and in this mode its temperature is 15°C.

**Important!** Do not store any food in the fridge during this time.

When the holiday function is on, you can switch it off by pressing any button of "Holiday", "Fridge" and "Super Cool" button. The fridge temperature setting will revert back to the previous setting.

## 4. Alarm



In case of alarm, "Alarm" icon will be on and there will be buzzing sound. Press "Alarm"

key to clear alarm and then "Alarm" icon will turn off and stop buzzing.

### Door Alarm

- When the door is open for over 2 minutes, the door alarm will sound. In case of door alarm, buzzer will sound 3 times every 1 min and will stop alarming automatically after 10 minutes.
- To save energy, please avoid keeping the door open for a long time when using the appliance. The door alarm can also be cleared by closing the door.

## 5. Power

If you want to clean the appliance or stop using it, you can turn the appliance off by pressing "Power" button.

- When the refrigerator is working, you can switch the appliance off by pressing "Power" button for 5 seconds, meanwhile the display panel will be turned off.

**Important!** Do not store any food in the fridge during this time.

- When the appliance is power off, you can switch the appliance on by pressing "Power" button for 1 second, and the refrigerator returns to the previous temperature setting.

## 6. Child Lock



You can press the "Child Lock" button in case children touch the buttons,

to avoid wrong set. When the Child Lock function is activated, pressing the other buttons would not work except "Alarm" button.

- When the appliance is unlocked, you can activate the child lock function by pressing "Child Lock" button for 3 seconds, meanwhile "Child Lock" icon will be illuminated.
- When the child lock function is activated, you can switch off this function by pressing "Child Lock" button for 3 seconds, meanwhile "Child Lock" icon will be turned off.

## Compulsory defrost

Connecting power within 1 minute, refrigerator or freezer door open situation, press Fridge and Quick frozen 3 seconds, enter the compulsory defrosting process:

—After entering the compulsory defrosting, we can run the defrosting same as the normal automatic defrosting process.

—Under compulsory defrosting process, displaying b area displays from 99 to 00.

After exiting the entire compulsory defrosting process, it reverts to normal operation and display.

## Checking the Compressor

Use a multi-meter to test the resistance between C & M, C&S and S&M :

Normal range of C&M : About 49.6  $\Omega$

Normal range of C&S : About 35.9  $\Omega$

Normal range of S&M : About 85.5  $\Omega$



If the test result is not in this range then it means the inner coil has some problem and the compressor can not work properly.

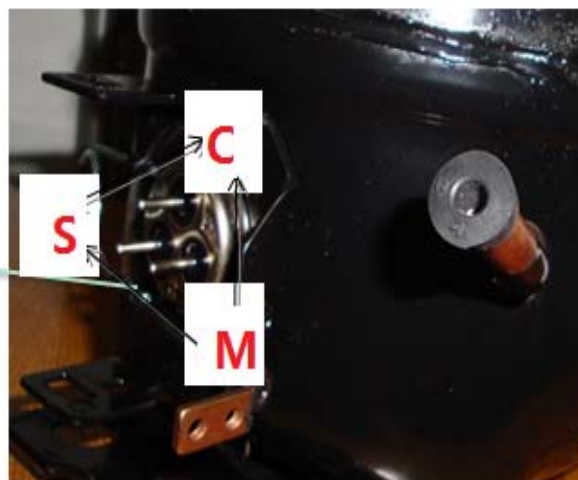

#### Compressor Protector test ———

Use a multi-meter to test the resistance between the two end as the pic show :

If there show 000 or almost 0 then it is OK.

If there is no response then it is broken.

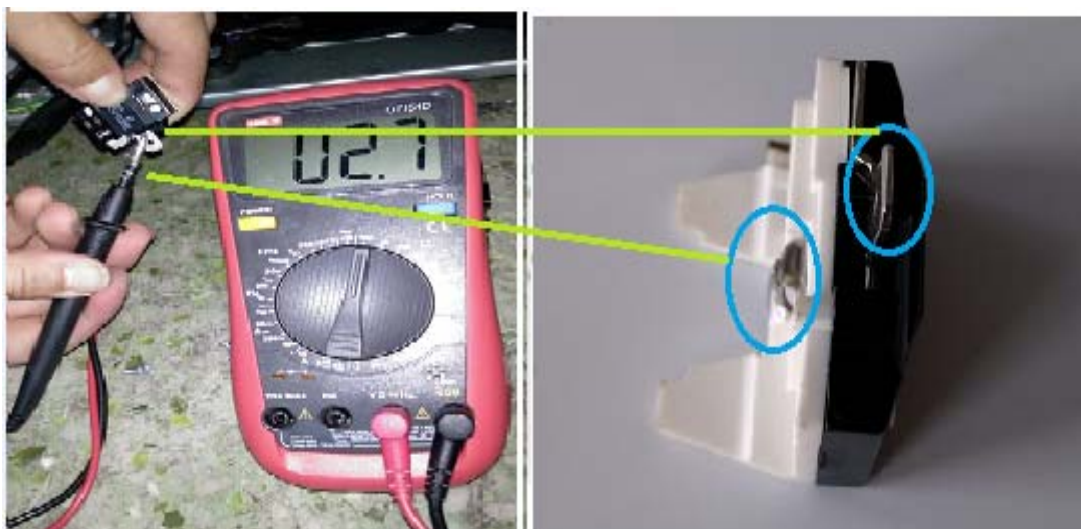

#### Compressor PTC starter test ———

Use a multi-meter to test the resistance between the two end as the pic show :

If there show the number is between About 9-25  $\Omega$  then it is OK.

If there show 000 or no response then it is broken.



## Checking the heater

If defrost system failure, check the heater and the temperature fuse as well as wires. Measuring temperature fuse and heater resistance about  $304\Omega$  then it is OK. (gray and Blue)

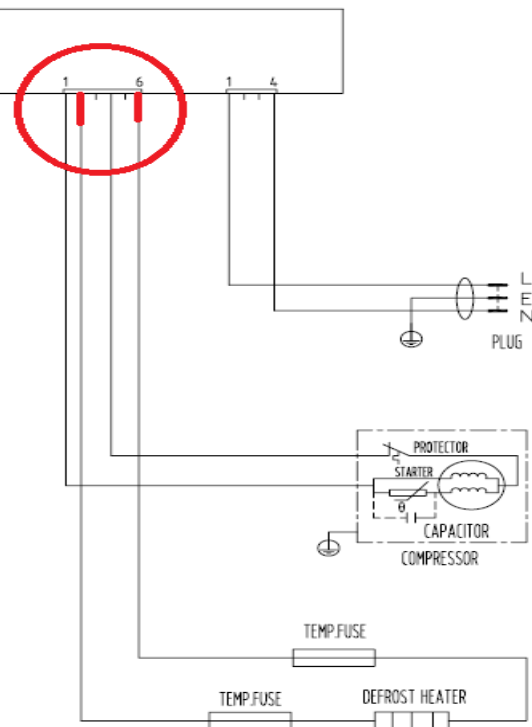

## Checking the defrost fuse

Fuse is a high temperature protector of defrost system, when defrosting, if it feel the temperature is more than  $73^{\circ}\text{C}$ , it will cut off the defrost heater, stopping defrost, so that it can protect the parts. The common problems are evaporator defrost incomplete:

Checking method as following:



Picture 1



Picture 2

As picture 1, it is the defrost fuse.

As picture 2, using the multimeter measure two foofs of fuse, if the value of resistance is 0000, it means normal.

## Measuring the sensor resistance

Rr sensor White line

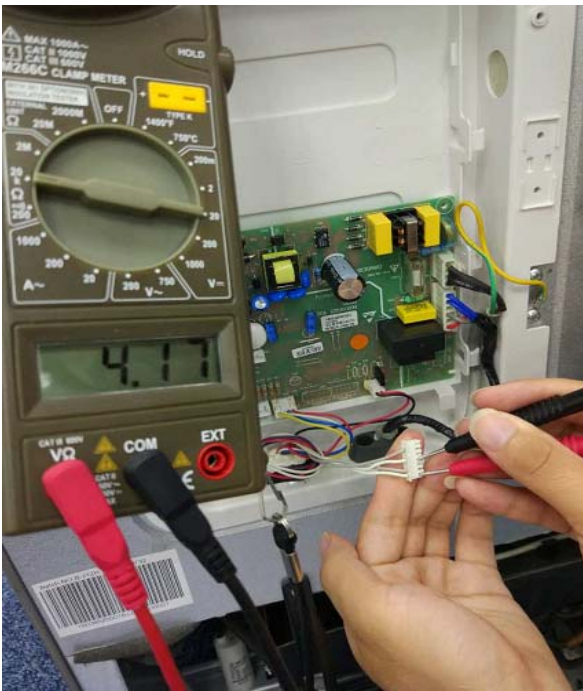

Rv sensor Gray line

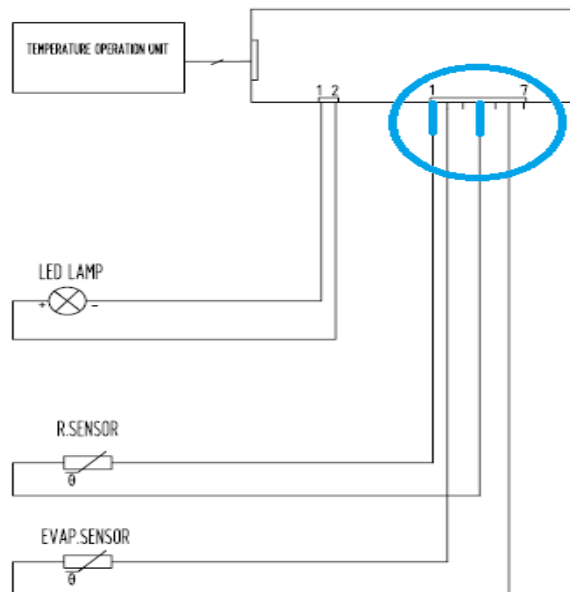



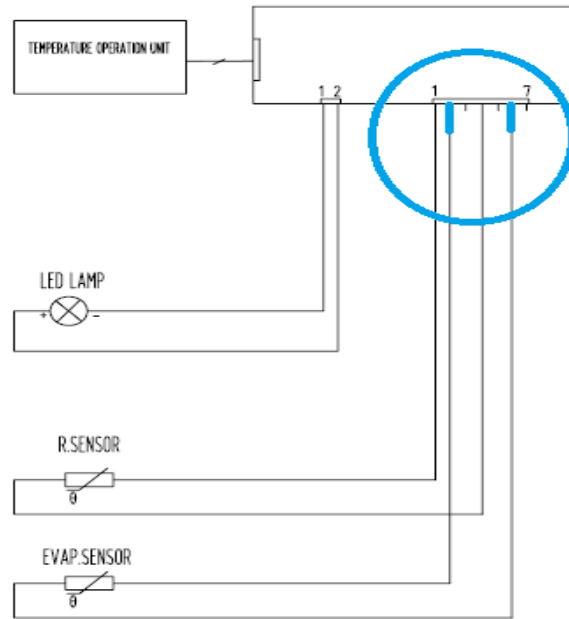
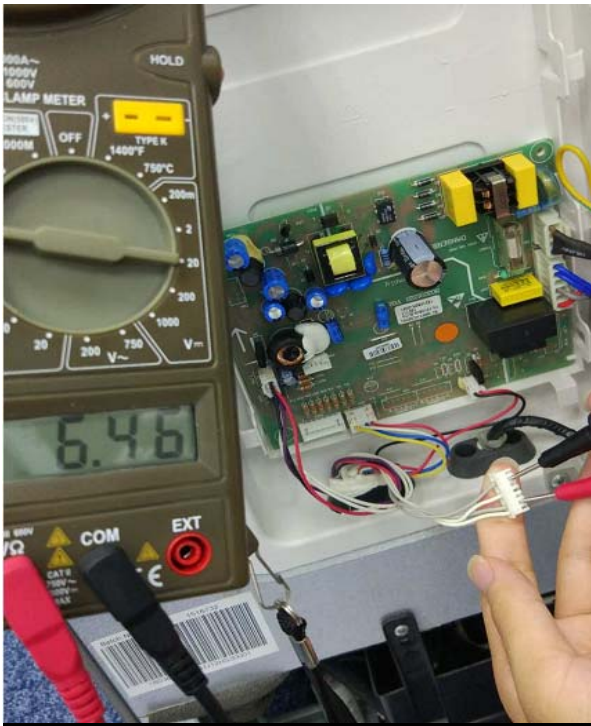

Using a multimeter with the ohm switch to measure the resistor of sensor, normally at surrounding 25°C the resistor should be about 2kohm and every with the temperature decreases 1°C the corresponding resistor value would increase about 45ohm. If the measured value is not within the normal scope, the sensor is bad and needs to repair or change.

## The guide for Disassembly Common parts of Refrigerator

### ◆ The instruction of replacing the main board and display board.

Unscrew the back cover screws

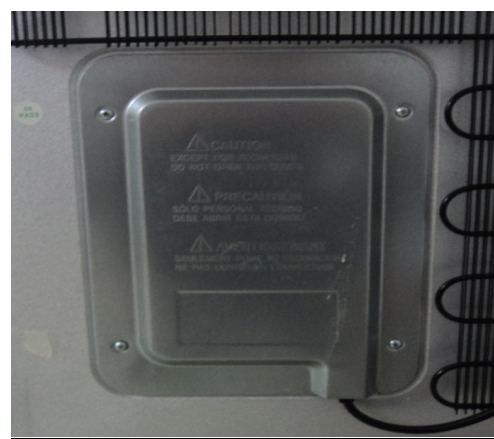

Remove the electron box cover and replace the main board.



### ◆ The instruction of of replacing fan motor

Remove the wind channel plate in freezer chamber.



Remove the air duct Board



Open air duct Board



Unscrew the fan motor screws  
And take out fan motor



◆ **The instruction of replacing temperature sensor.**

Open air duct Board  
And take out sensor



◆ **The instruction of replacing evaporator temperature sensor and temperature fuse and heater**

The instruction of replacing evaporator temperature sensor and temperature fuse

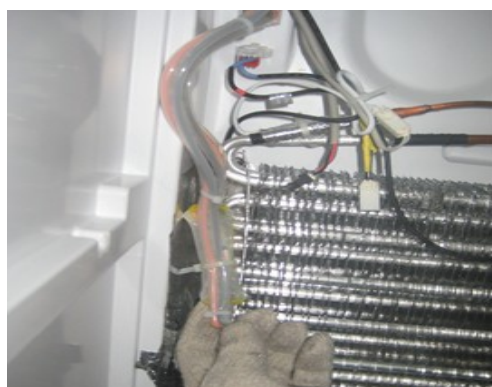



The instruction of replacing heater



◆ The instruction of replacing PTC Starting relay and Overload protector.

1. The location of the PTC Starting relay and Overload protector.

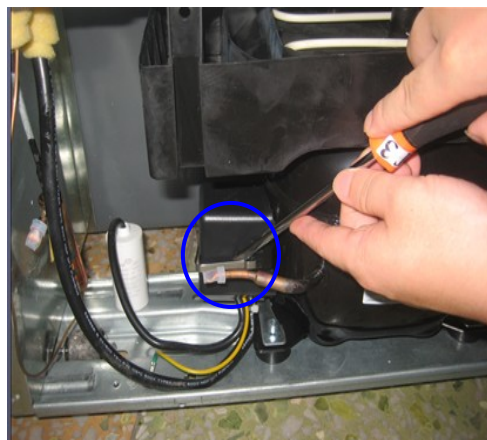

2. Disconnect the connecting wire of the PTC Starting relay and Overload protector.



◆ The instruction of replacing Door switch.

Using a screwdriver to pry the upper cover plate  
And take out switch



### ◆ The instruction of replacing Display board.

1. The location of the display board .



2. Unplug the display board wires and remove the screws fixing .



### ◆ The instruction of replacing LED Light.

1. The location of the LED light.





2. Unplug the electrical wires and remove the screws fixing the LED light board.



## Installing your new appliance

Before using the appliance for the first time, you should be informed of the following tips.

### Ventilation of appliance



In order to improve efficiency of the cooling system and save energy, it is necessary to

maintain good ventilation around the appliance for the dissipation of heat. For this reason, sufficient clear space should be available around the refrigerator.

**Suggest:** It is advisable for there to be at least 75mm of space from the back to the wall, at least 100mm from its top, at least 50mm from its side to the wall and a clear space in front to allow the doors to open 135°. As shown in follow diagrams.

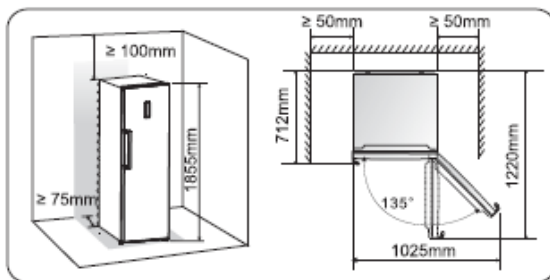

### Note:

- Stand your appliance in a dry place to avoid high moisture.
- Keep the appliance out of direct sunlight, rain or frost. Stand the appliance away from heat sources such as stoves, fires or heaters.

### Leveling of appliance

- For sufficient leveling and air circulating in the lower rear section of the appliance, the bottom feet may need to be adjusted. You can adjust them manually by hand or by using a suitable spanner.
- To allow the doors to self-close, tilt the top backwards by about 10mm.

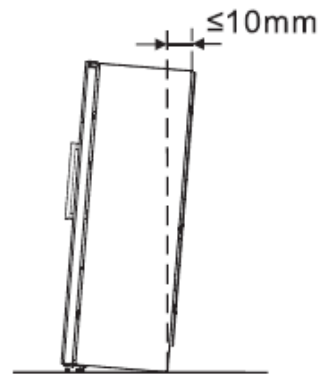

### Installing the door handles

For the convenience of transportation, the door handles are separately provided in a plastic bag, you can install the door handles as follows.

1. Lever screw covers on the left side of the door, and then put them back to the plastic bag.
2. Match the handle on the left side of the door, keeping axes of screw holes in the handle and the door in a line, as the picture shows.
3. Fix the handle with the special screws provided in the plastic bag.

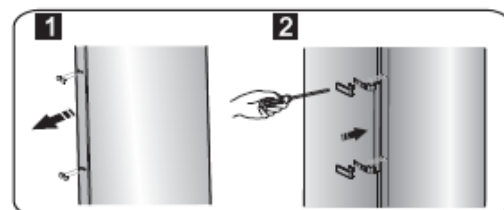



## Reversing the door

The side at which the door opens can be changed, from the right side (as supplied) to the left side, if the installation site requires.

**Warning!** When reversing the door, the appliance must not be connected to the mains. Ensure that the plug is removed from the mains socket.

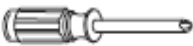
Tools you will need:

	
8mm socket wrench	Cross-shaped screwdriver
	
Thin-blade screwdriver	8mm wrench

**Note:** Before you start lay the refrigerator on its back in order to gain access to the base, you should rest it on soft foam packaging or similar material to avoid damaging the backboard of the refrigerator. To reverse the door, the following steps are generally recommended.

1. Stand the refrigerator upright. Open the door to take out all door racks (to avoid racks damaged) and then close the door.

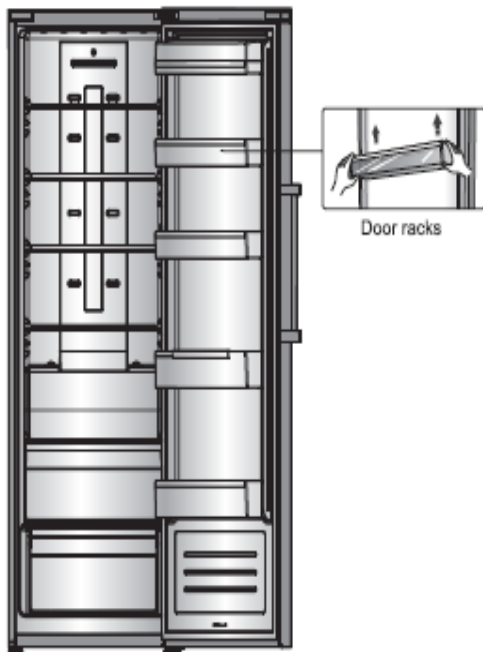

2. Open part ① on top of the refrigerator body from right side and then take down part ③ and part ④ on the door in the same way. Take down part ② and put it back to the plastic bag.

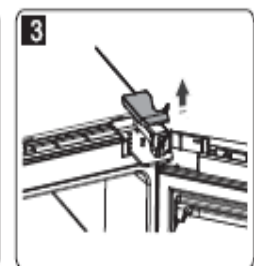
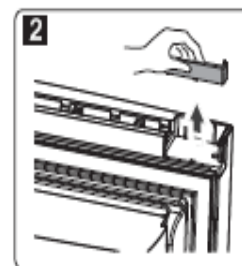
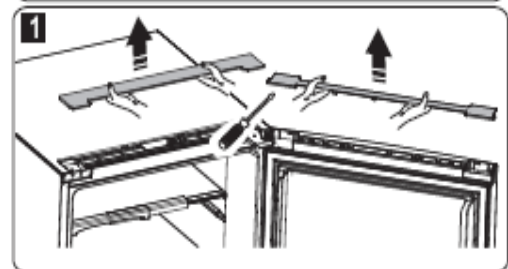
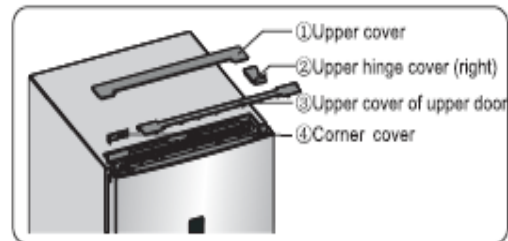

3. Disconnect electrical connector ① as well as electrical connector ② and then take down part ③.

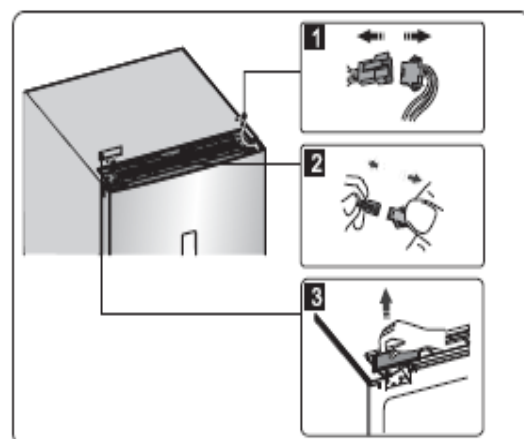

4. Remove the screws ①, loose wire ②, and remove part ③.

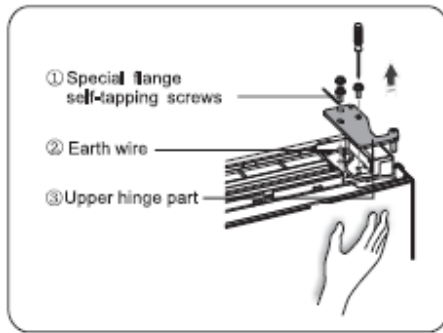

**Note:** Please hold the door by hand during step 4 to prevent door dropping.

5. Remove the door and place it on a smooth surface with its panel upwards. Lever part ① and part ④, then loose screws ②, as shown in the picture. Change handle ③ to the right side, then install screws ②, part ① and part ④ in turn. Loose screws ⑦, detach part ⑥ and part ⑤, turn part ⑧ over and then install part ⑤ and part ⑥ to the left side with screws ⑦.

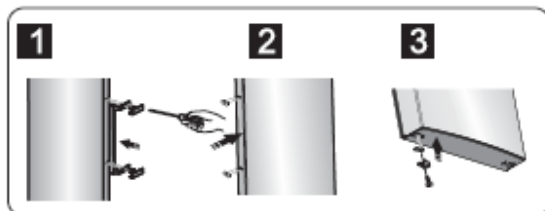
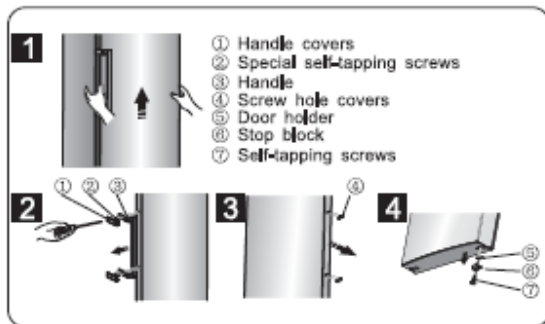

6. Place refrigerator flatwise, remove part ③ and then loose screws ④. Remove part ② and part ①.

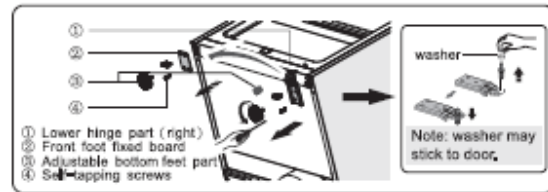

7. Screw out lower hinge, change it to the near hole site, and then screw up and mount washer.

8. Just remount to the step 6, change part ① to left and part ② to right and then fix them with screws ④. Finally install part ③.

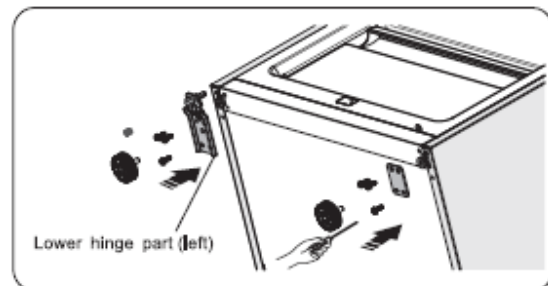

9. Screw out the upper hinge axis, turn the upper hinge over and fix axis on it. Then place it at side for use.

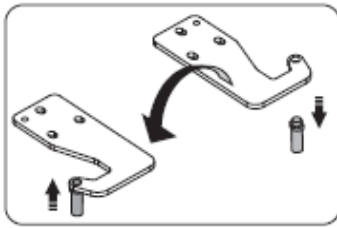

10. Exchange wires both in the left and right slots of refrigerator body.



11. Move the door to appropriate position, adjust part ① and the door, Move the connecting wire ② in the slot of the door from right to left, and then fix part ① and wire ② by screws ③. (Please hold the door by hand when installing)

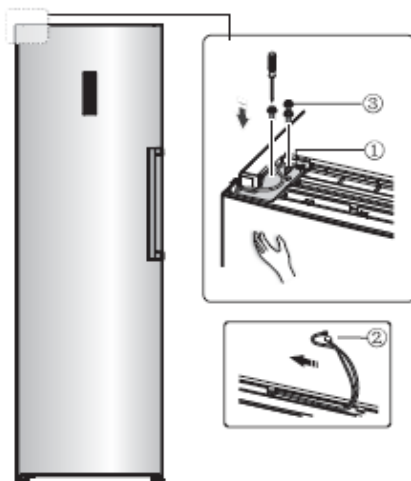

12. Connect electrical connector ① in accordance with step 3 and then install part ② (which is in the plastic bag).

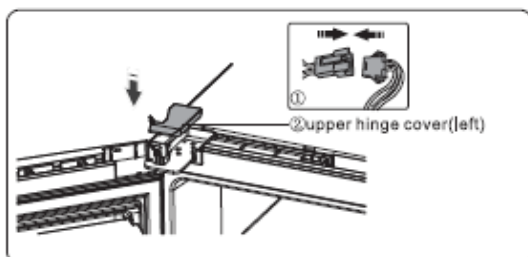

13. Reverse part ① by 180° and install it onto the right corner of the door, then mount part ②. (both of which are taken down in step 2)

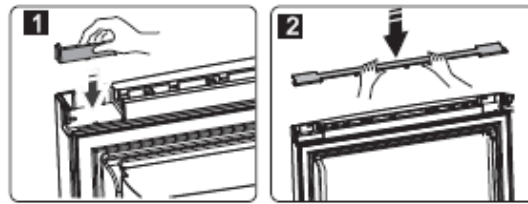

14. Take the reed switch out of the coping block (part ③ in step 3) and mount it on another block for use (which is with mark "R" in the plastic bag). Put the coping block just removed back to the plastic bag.

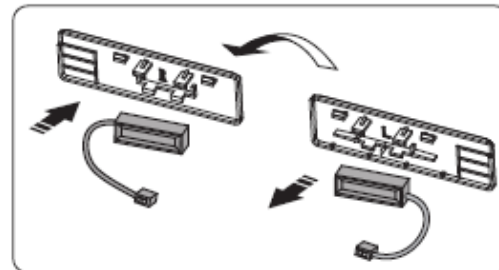

**Note:** Be sure character side of reed switch fits well with coping block.

15. Install part ①, connect the wire connector ②, and then install part ③.



16. Open the door, mount door racks and then close it.

## Troubleshooting

### ◆ The solution for digital display code problem:

1	The digital display window show "E1"	<ol style="list-style-type: none"> <li>1. The Refrigerator chamber Tem. Sensor is open circuit or short circuit.</li> <li>2. The Refrigerator chamber Tem. Sensor is bad.</li> <li>3. The control PCB is bad.</li> </ol>	<ol style="list-style-type: none"> <li>1. Using a Multimeter with the ohm switch to measure the resistor of sensor or checking the connecting is well or not.</li> <li>2. Change the sensor</li> <li>3. Change the control PCB</li> </ol>
2	The digital display window show "E2"	<ol style="list-style-type: none"> <li>1. The Evaporator Defrost Sensor is open circuit or short circuit.</li> <li>2. The Evaporator Defrost Sensor is bad.</li> <li>3. The control PCB is bad.</li> </ol>	<ol style="list-style-type: none"> <li>1. Using a Multimeter with the ohm switch to measure the resistor of sensor or checking the connecting is well or not.</li> <li>2. Change the sensor</li> <li>3. Change the control PCB</li> </ol>
3	The digital display window show "EC"	<ol style="list-style-type: none"> <li>1. The receive communication fault between the main electrical PCB and the display PCB.</li> <li>2. The control PCB is bad.</li> <li>3. The display PCB is bad.</li> </ol>	<ol style="list-style-type: none"> <li>1. Check the wire terminal is well or not between the main electrical PCB and display PCB.</li> <li>2. Change the main electrical PCB.</li> <li>3. Change the display PCB.</li> </ol>
4	The freezer digital display window show "EF"	<ol style="list-style-type: none"> <li>1. The Fan motor is open circuit or short circuit.</li> <li>2. The Fan motor is bad.</li> <li>3. The control PCB is bad.</li> </ol>	<ol style="list-style-type: none"> <li>1. Using a Multimeter with the ohm switch to measure the resistor of Fan motor or checking the connecting is well or not.</li> <li>2. Change the Fan motor</li> <li>3. Change the control PCB</li> </ol>

The testing method of sensor:

Using the multimeter with the ohm switch to measure the resistor of sensor, normally at surrounding 25°C the resistor should be about 2kohm and every with the temperature decreases 1°C the corresponding resistor value would increase about 45ohm. If the measured value is not within the normal scope, the sensor is bad and needs to repair or change.

### ◆ The common problem judgement method

Problem	Cause
Refrigerator can't start	<ol style="list-style-type: none"> <li>1.1 Is the power cord connecting well?</li> <li>1.2 Is the power voltage too low?</li> <li>1.3 Is the sensor irrational setting?</li> <li>1.4 Is the ambient temperature too low?</li> <li>1.5 Is the circuit on power?</li> <li>1.6 Is there some default in compressor</li> <li>1.7 Is the refrigeration system blocked by ice or dirty, please stop the unit and restart after 10 minutes to see if the compressor can start.</li> </ol>
Weak cooling effects	<ol style="list-style-type: none"> <li>2.1 Is there any heat source around the refrigerator?</li> </ol>

	<p>2.2 Is there enough space around the refrigerator for rejection of heat?</p> <p>2.3 Is the setting of the temperature appropriate?</p> <p>2.4 Is there too much food or overheating food in it?</p> <p>2.5 Does there open the door frequently?</p> <p>2.6 Is the door completely closed?</p> <p>2.7 Does the gasket destroyed or distort?</p> <p>2.8 Does the gas leak?</p>
The unit can not stop running	<p>3.1 Is there any heat source around the refrigerator?</p> <p>3.2 Is there enough space around the refrigerator for rejection of heat?</p> <p>3.3 Is the setting of the temperature appropriate?</p> <p>3.4 Is there too much food or overheating food in it?</p> <p>3.5 Does there open the door frequently?</p> <p>3.6 Is the door completely closed?</p> <p>3.7 Does the gasket destroyed or distort?</p> <p>3.8 Is the thermostat good operation?</p> <p>3.9 Does the gas leak?</p>
Ice up in the freezing chamber	<p>4.1 Is the setting of the temperature appropriate?</p> <p>4.2 Is there multi-moisture food and too close to the back wall of the refrigerator?</p> <p>4.3 Is the ambient temperature too low?</p> <p>4.4 Is the electric parts on good condition, specially the thermostat which will cause the unit non-stopping .</p>
Abnormal noise	<p>5.1 Is the refrigerator stably placed?</p> <p>5.2 Does the refrigerator bump other objects?</p> <p>5.3 Whether the internal accessory of the refrigerator is in the right place.</p> <p>5.4 Whether the water plate of compressor is fall from the unit.</p> <p>5.5 Does the tube of the refrigeration system bump each other?</p> <p>5.6 The noise sound likes Water flow inside the refrigerator ,in fact ,it is normal, which is caused both when refrigerator start and shut-down; in addition, frost-dissolving causes this sound, too, which is a normal phenomenon.</p> <p>5.7 There will be a cracking sound in the cabinet ,when the cabinet or cabinet accessory contracting or expanding, this sound will be made, which is normal.</p> <p>5.8 The motor operation sound in the compressor is appears to be louder at night or begin starting. which is a normal phenomenon; also the uneven placing would lead to too much running noise.</p>
There is a peculiar smell in the units	<p>6.1 Is the food with special smell sealed tight?</p> <p>6.2 Does it have long time storing food or degenerated food?</p> <p>6.3 Whether the internal cabinet needs cleaning.</p>
the forefront or the middle cabinet heats	<p>7.1 As fridge Anti-condensation tube is placed here and caused the above phenomenon, which is normal.</p>
Refrigerator's two sides or the back heat	<p>8.1 As condensation tube is placed here and caused the above phenomenon, which is normal.</p>
the cabinet surface condensation	<p>9.1 Air humidity is too large.</p>

### ◆ The solution for the common problem.

1.Cooling is not enough good

(Many reasons might cause that cooling not enough good, as blow :)		
Reason	analysis	Solutions
1) Leakage of Gas	<p>If some gas leaked unit will work not well.</p> <p>Phenomenon of failure:</p> <p>a. lower pressure of liquid cycle system</p> <p>b. high temperature of copper tube of discharging gas, hand feels very hot.</p> <p>C. much noise, sounds like "ZZZZZ", comes from outlet of capillary.</p> <p>d. the temperature fell down very slowly.</p>	<p>First find out the point of leaking on tube, and then sealed it, vacuuming it, finally recharge with Gas.</p> <p>Note:</p> <p>If you find oil on somewhere, it is possible that leakage point is there.</p>
2)The quantity of Gas is too much	<p>If too much Gas was charged into the cycle system, the extra gas will occupy some space of evaporator, so that the area of heat exchange becomes less, unit will work not well.</p> <p>Phenomenon of failure:</p> <p>a, higher pressure of liquid cycle system than norm.</p> <p>b, higher temperature of condenser.</p> <p>c, larger electric current of compressor</p> <p>d, there maybe ice on the suction tube.</p> <p>e, when gas is too much, some gas liquid might goes back into compressor, compressor will be damaged by liquid.</p>	<p>First stop unit for several minutes, and then open charging tube, discharge all of gas. Change a new filter, and then recharge gas, finally sealed the system.</p>
3) There is air in the liquid cycle system	<p>The air in system will cause lower efficiency of cooling.</p> <p>Phenomenon of failure:</p> <p>a, higher pressure of liquid cycle system than norm, but the pressure is not over the limit.</p> <p>b, higher temperature of discharging tube.</p> <p>C, much noise</p>	<p>First stop unit for several minutes, and then open charging tube, discharge all of gas. Change a new filter, and then recharge gas, finally sealed the system.</p>
4)Low working efficiency of compressor	<p>General when a compressor works for many years, some parts of compressor were wear, so that compressor discharge less gas out, unit does not work strongly.</p> <p>Phenomenon of failure:</p> <p>a, lower pressure of discharging, check the pressure of system with pressure meter to see if it is normal.</p> <p>b, higher temperature of compressor surface.</p> <p>C, cut off the discharging tube, to see if you can block the gas coming out of the tube when compressor is working.</p>	<p>Change a new compressor.</p>
5) There is something that blocked the liquid cycle system	<p>Some time there is something blocked the filter of liquid cycle system, so that unit is not cold.</p> <p>Phenomenon of failure:</p> <p>a, lower pressure of discharging</p>	<p>Change a new filter</p>

	b, lower temperature of discharging.	
2.NO COOL (Popular failure reasons are below):		
Reason	analysis	Solutions:
1) Leakage of gas	Phenomenon of failure: a, leaking fast b, leaking slowly c, no voice of liquid flowing d, cut off charging tube, no gas goes out.	First find out the point of leaking on tube, and then sealed it, vacuuming it, finally recharge with gas. Note: If you find oil on somewhere, it is possible that leakage point is there.
2)There is some thing that blocked the liquid cycle system	A,Ice blocking Sometime because unknown reason water comes into liquid cycle system, the capillary will be blocked by water after unit runs for period of time. Phenomenon of failure: The unit works well in the inception, after period of time the ice appears in the capillary and becomes more and more, till blocks the hole of capillary completely. In the moment you can find the ice on the evaporator defrosts. The noise of liquid flow disappears. The pressure of absorbing becomes negative. The phenomenon above will appear again and again. The way to check ice blocking: Warm the capillary with a hot towel, after a while the ice in the capillary melt, you can hear a sound of gas flow comes from the capillary abruptly. The pressure of absorbing becomes higher. It is Ice blocking.	First stop unit for several minutes, and then open charging tube, discharge all of gas. Blow the cycle system with gas of nitrogen, and then recharge Gas, finally sealed the system.
	B, there is offal block the capillary Phenomenon of failure: If the capillary is blocked by something such as offal etc., the sound of liquid flow disappears. The ice on the evaporator defrosts The pressure of absorbing becomes negative. Higher temperature of discharging tube The way to check offal blocking: If you warm capillary with the way of	First stop unit for several minutes, and then open charging tube, discharge all of gas. Blow the cycle system with gas of nitrogen. Change a new capillary and filter, and then recharge Gas, finally sealed the system.



	checking ice blocking, there is no change. It must be offal blocking.	
<b>COMPRESSOR NEVER STOPS:</b>		
	<b>Reason</b>	<b>Solutions</b>
1)	The setting temperature is not reasonable.	Readjust the temperature setting.
2)	the sensor is bad.	Replace the sensor.
3)	Seal of door is damaged.	Replace the gasket
4)	Too much food in the refrigerator	Please put the food properly.
5)	Wind door is broken.	Replace wind door.
6)	Fan motor is broken.	Replace fan motor

■ **NOTE:**

- Before doing these operations above, disconnect the main power supply. Failure to do so could result in electrical shock or personal injury.
- In case of any detailed technical information please check with the technical specifications.